

*it's all about space!*  
**Smart Storing**

MAGAZINE  
EDITION 4

**Save money  
in 5 ways**



Save on space & storage costs



Save on picking time



Save on internal transports



Save on costs due to workplace injuries



Save on walking distance



DESIGN &  
MANUFACTURING  
IN SWEDEN

**Smart Storing**



**LOGITEC**

**DISTRIBUIDOR AUTORIZADO**  
Idorsolo, 13 - P.E. San Isidro I  
48160 - Derio (Vizcaya)  
Tel. +34 944544580  
Web: [www.logitecsl.net](http://www.logitecsl.net)

# Save money in 5 ways



**Save on space &  
storage costs**



**Save on picking time**



**Save on internal  
transports**



**Save on costs due  
to workplace injuries**



**Save on walking  
distance**

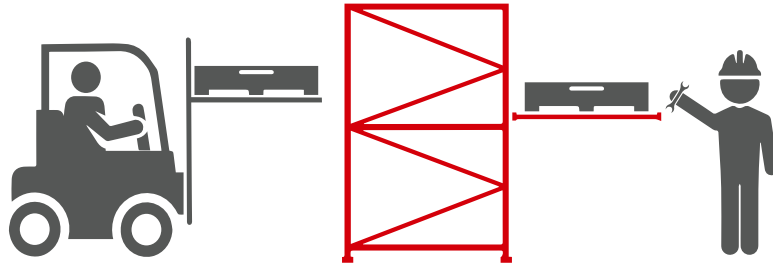

→ Kjell Johansson, MD Smart Storing

**”Far too many companies lose a lot of time and money by not storing and picking materials in an efficient and ergonomic way.**

**That's why we provide flexible storage solutions with pull-out shelves.**

**I call that smart storing.”**

A handwritten signature in purple ink, appearing to read 'Kjell Johansson', with a long horizontal flourish extending to the right.

# Contents

- 6 – 15 Save money in 5 ways
- 16 – 17 Background & philosophy
- 18 – 19 Delivery & installation
- 20 – 21 Tailor-made storage systems
- 22 – 23 Product group chart

**NEW PRODUCT  
GROUP CHART!**

## 24 PULL-OUT UNITS

- 26 – 27 Help choosing the right one
- 28 – 33 Beam-mounted
- 34 – 37 Beam-mounted accessories
- 38 – 40 Floor-mounted
- 41 – 43 Floor-mounted accessories
- 44 – 47 Trojka – Pull-out shelving
- 48 – 50 Wide
- 51 Wide accessories
- 52 – 54 Upright-mounted
- 55 Upright-mounted accessories
- 56 – 57 Electric

**NEW!** page 32–33  
R1 – Rotable pull-out unit

**NEW!** page 35  
Wire shelf

**NEW!** page 44–47  
Trojka – Pull-out shelving

## 58 STORAGE MODULES

- 60 – 61 Compact Storage Units (CSU)
- 62 – 63 Help choosing the right one
- 64 – 69 Compact Storage Units (CSU)
- 70 – 71 CSU Light
- 72 – 75 Compact Storage Units accessories
- 76 – 79 Mobile Pallet Units (MPU)
- 80 – 83 Tool Storage Units (TSU)
- 84 – 87 Pallet Storage Units (PSU)

**NEW!** page 69  
Electric tugger for Compact  
Storage Modules

**NEW!** page 70–71  
CSU Light

**NEW!** page 80–83  
Tool Storage Units – TSU

**NEW!** page 84–87  
Pallet Storage Units (PSU)

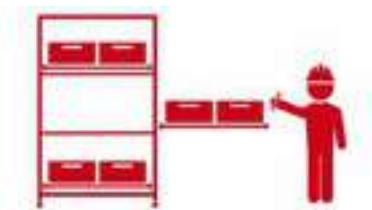
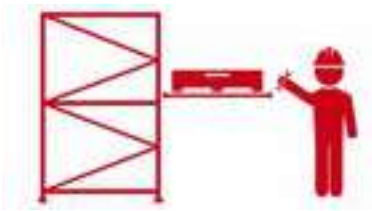

**NEW!** page 95  
Cable drum storage

**NEW!** page 97  
Tire cart

**NEW!** page 98  
FIFO cart

**NEW!** page 99  
Pallet cart

**NEW!** page 102-105  
Timber storage rack

**NEW!** page 106-111  
Loop storage racks

## 88 PRODUCTION LINES & AREAS

- 90 - 93 FIFO flow shelves
- 94 - 95 Accessories
- 96 - 99 Mobile carts



## 100 LONG GOODS

- 102 - 105 Timber storage rack
- 106 - 111 Loop storage racks



## 112 ACCESSORIES

- 114 - 117 Pallet accessories
- 118 - 119 Picking and storage bins
- 120 - 123 Marking and labelling



- 124 - 125 From order to delivery - How it works
- 126 Contact
- 127 - 129 Personal notes
- 130 Our customers



A woman with long blonde hair, seen from behind, is wearing a red t-shirt with the text "It's all about space!" printed in white. She is holding a black pallet jack in a warehouse setting. The background shows wooden pallets, a yellow hard hat, and industrial equipment. The text on the shirt is in a bold, sans-serif font.

***It's all  
about  
space!***

IT'S ALL ABOUT SPACE  
**Save money in 5 ways**

# 1. **Save on space and storage costs**

Our products mean you can store more stuff in less space. This frees up valuable floor space and/or increases your storage capacity. Why expand when you can simply use your existing space in a smarter way?

Warehouses are often full of pallet racking which is holding mostly air. Storage units sized to suit your exact needs help to make your space work for you.

Pull-out units are a key feature of a modern, rational storage system.



Niklas Jokumsen, XL Bygg Varekil

**”We are extremely pleased with Smart Storing’s timber storage solution and the support we have received.”**







IT'S ALL ABOUT SPACE  
**Save money in 5 ways**

*Time is money!*

## 2. Save on picking time

Picking items from pallet racking takes time. Often a fork lift must be used to lift a pallet down before components can be picked. That means the picker standing idle while he waits for a fork lift driver. Then the fork lift driver sitting idle while he waits for the picker. Not an efficient use of manpower!

Pull-out units at a sensible height mean that a single worker can get immediate access to the goods or components needed, even those deep inside the pallet. There's no waiting if the fork lift is unavailable, and no waste of staff time.



Åsa Johnsson, El-Björn AB

**”We have greatly benefited from using Smart Storing's plastic pockets for labeling our products.”**



IT'S ALL ABOUT SPACE  
**Save money in 5 ways**

*Optimize!*

### **3. Save on internal transports**

Since items can be accessed and picked manually by one person, there will be less driving around with fork lifts. Less use of fork lifts means time saved, lower maintenance costs, a potential for a reduction in the number of trucks, and lower labour costs.

Having good access to your stores makes it easier to keep them organized, too. When items are easy to find and to get hold of, less time is spent searching for them, fewer items get damaged and order-picking is more efficient.



Jonas Wilén, Grundsunds Marina AB

**”Smart Storing provided us  
with smart storage solutions  
for our boats and spare parts.”**





## 30 picking locations – three different storage solutions



Smart Storing's solution  
with Compact Storage Units  
= 6 m  
30 picking locations

Smart Storing's solution  
with pull-out units  
= 10 m  
30 picking locations

Standard pallet rack  
with single-level picking  
= 30 m  
30 picking locations

IT'S ALL ABOUT SPACE  
**Save money in 5 ways**

*Distance matters!*

## 4. **Save on walking distance**

Since the storage density can be much higher with pull-out units and compact storage units, the walking distance between warehouse items can also be reduced, saving even more time. This is especially important in operations with high picking frequencies, such as distribution centers and e-commerce. Smart Storing reduces walking and picking distances. See the example on the left side with 30 picking positions and three different storage solutions.



Tomas Sundler, Parts Precision Sweden AB

**”Thanks to Smart Storing’s  
products, we were able to  
optimize the handling and  
storage of long goods.”**



IT'S ALL ABOUT SPACE  
**Save money in 5 ways**

*Good ergonomics!*

## **5. Save on costs due to workplace injuries**

We all need to take care of our personnel. Ergonomics is no longer a luxury – it's a crucial aspect for every business and has a significant impact on profitability. The single biggest cause of workplace injuries in any business, accounting for 25% of the direct costs, is 'over-exertion', defined as injuries caused by lifting, pushing, pulling, holding and carrying.

Easy-access storage and picking systems result in fewer strains and injuries for the staff. Save money by keeping your staff in good shape!



Lena Johansson, Smart Storing

**”It feels rewarding to contribute to businesses by improving workplace ergonomics.”**



DESIGN &  
MANUFACTURING  
IN SWEDEN



# Background & Philosophy

## OUR ROOTS

The company was founded in 1986 by the current owner and MD, Kjell Johansson. He saw three crucial openings in the market for an engineering company with smart solutions: the need for more compact storage of materials, faster picking processes, and better ergonomics in the workplace.

**”We use only high-quality materials, and we like to believe that Swedish steel is the best.”**

The Swedish manufacturing industry has a well deserved reputation for excellent technology, production, and quality. We use only high-quality materials, and we like to

believe that Swedish steel is the best.

This is where Smart Storing comes from – a craftsman’s understanding of materials, an engineer’s grasp of design and efficiency and an innovator’s ability to find new solutions for modern industry.

## DESIGN AND CONSTRUCTION

Design and technology are fundamental factors in our success. We use a 3D-based CAD system in our design work – not just for our own ease, but also to share drawings and computer-generated images with our customers. We can present exactly what you will receive, even during the design stage!

## PRODUCTION

All steel products are manufactured in our factory on Orust using carefully selected materials. For efficient mass production, we

### DID YOU KNOW THAT WE HAVE...

- The industry’s largest range of pull-out units
- Over 30 years of experience in manufacturing material handling equipment.
- Well-trained production staff who share responsibilities.
- In-house design and production, providing excellent opportunities for product customization
- Sales representatives with extensive experience in project sales and material handling.





Amanda, welder at Smart Storing

**”The weld joints contribute to our products being able to withstand high loads.”**

have automatic CNC machines and welding robots. For prototypes and low-volume products, we have skilled workshop mechanics who can do the job more craftily. This combination of craftsmanship and automation allows us to be flexible, competitive and fast, whether it's a large or small order.

## SAFETY IS NO ACCIDENT

We take safety seriously at every step of our process; we don't want people to get hurt. Therefore, we conduct rigorous tests and load tests on all our models to meet our high standards for durability and functionality.

**”..lower storage costs, faster turnover, and a better work environment.”**

## WHY CHOOSE SMART STORING?

Quality, safety, and customer service are our guiding principles and are prioritized by the entire company. Our ambition is to offer you technical solutions that meet your needs for lower storage costs, faster turnover, and a better work environment.



# Effortless delivery

## READY TO USE!

Most of our products are delivered fully assembled and function-tested. This means you don't have to spend time assembling what you purchase from Smart Storing. You can feel confident in the functionality and warranty of our products.

## PACKING

Few things are more annoying than receiving damaged goods. We take a pride in packing our products so they arrive without defects.

For pull-out units, we use approved EUR pallets and wooden spacers between each unit. We secure the pallets with strong plastic band made of recycled PET material in multiple directions to keep the pull-out units in place. We protect the products with sturdy corner guards and then cover the pallet with multiple layers of stretch film.

Our Compact Storage Units are delivered on specially designed pallets that are larger than the product, providing extra protection against mishandling.

## DELIVERY

Smart Storing is located on Orust, which is situated 80 km north of Gothenburg, Sweden's industrial center. We deliver primarily to Europe, but also in projects to the rest of the world. We are used to handling customs administration.

We are happy to arrange delivery to your doorstep. By letting us take care of it, you can save time on freight procurement, volume calculations, and ensuring you have the right insurance and all documentation in order. We can handle the entire job for you.

Keron, assembler Smart Storing

**“We assemble each product with precision to guarantee that every component and customization aligns perfectly with the customer's desires.”**





# Tailor-made storage systems

We don't just produce standard mass-produced products - we can tailor a product for you to make it optimal in terms of dimensions, appearance, or function. Our most requested customization is a completely unique RAL colour.

Contact us at  
[info@smartstoring.se](mailto:info@smartstoring.se)  
or +46 304 80 90 80

We are open to suggestions for other types of customizations. Please get in touch with your needs and preferences.

## DID YOU KNOW THAT WE HAVE...

- In-house design and production capabilities that allow us to fully customize products.
- Sales representatives with extensive experience in project sales and material handling who can assist with special solutions.

# Anything is possible!

## SOME EXAMPLES OF TAILOR-MADE PRODUCTS



### CONTAINER INVERTER

A machine that turns a larger plastic container upside down to empty small components onto a sorting table, which are then collected in a smaller plastic container on a counting scale. The machine is also equipped with a height-adjustable table for adjustment to a tall or short operator.



### PULL-OUT UNIT WITH CONVEYOR ROLLERS

The perfect 'Kanban solution' with one or more pallets in queue. Both cost-effective and ergonomic product picking directly from the pallet. When the pallet is empty, it is removed, and the pull-out unit is pushed back in. Then, with the help of your foot, you can press down on a release mechanism, which releases a pallet stop at the next pallet in the waiting position. The waiting pallet then begins to roll down and stops smoothly with the help of braking rollers.



### A MINI COMPACT STORAGE UNIT WITH PERFORATED SHELVES

A special smaller-sized CSU designed for storing valuable textiles within the church. The shelves are perforated to provide ventilation, ensuring the textiles have a much longer lifespan.

Mark your preferences!



Product group chart	LOADING					PICKING
	HAND PALLET TRUCK	STACKER	FORKLIFT	OVER HEAD CRANE	BY HAND	OVER HEAD CRANE
<b>PULL-OUT UNITS</b>						
BEAM-MOUNTED STANDARD		X	X			
BEAM-MOUNTED + STEEL SHELF PANEL		X	X	X	X	X
BEAM-MOUNTED REINFORCED CORNERS		X	X	X		X
FLOOR-MOUNTED STANDARD	X	X	X			
FLOOR-MOUNTED + STEEL SHELF PANEL			X	X	X	X
FLOOR-MOUNTED REINFORCED CORNERS	X	X	X	X		X
FLOOR-MOUNTED TROJKA - PULL-OUT SHELVING					X	
WIDE STANDARD		X	X	X	X	X
WIDE + STEEL SHELF PANEL		X	X	X	X	X
UPRIGHT-MOUNTED STANDARD		X	X			
UPRIGHT-MOUNTED + STEEL SHELF PANEL		X	X	X	X	X
<b>STORAGE MODULES</b>						
COMPACT STORAGE UNITS (CSU)				X	X	X
CSU LIGHT	X	X	X			
MOBILE PALLET UNITS (MPU)		X	X			
TOOL STORAGE UNITS (TSU)				X	X	X
PALLET STORAGE UNITS (PSU)		X	X			

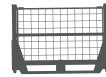
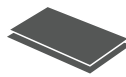

PICKING	GOODS						CAPACITY KG	PAGE
BY HAND	PALLET	BINS & BOXES	HEAVY TOOLS	LONG MATERIAL	SHEET MATERIAL	WIRE MESH CONTAINER		
								<b>24</b>
X	X						300 - 1500	30 - 31
X	X	X	X		X		200 - 1500	30 - 33
X	X					X	800 - 1500	30 - 31
X	X						800 - 1500	40
X	X	X	X		X		800 - 1500	40 + 42
X	X					X	800 - 1200	40
X		X					70 - 200 / shelf	46 - 47
X	X			X	X		400 - 1600	50
X	X	X		X	X		400 - 1600	50 + 51
X	X						600 - 800	54
X	X	X	X		X		200 - 800	54 + 56
								<b>62</b>
X		X			X		150 - 300 / shelf	68 - 72
X		X					75 / shelf	74 - 75
X	X				X		300 / shelf	82 - 83
X		X	X		X		600 - 1500 / shelf	86 - 87
X	X						600 / shelf	90 - 91







Pull-out units

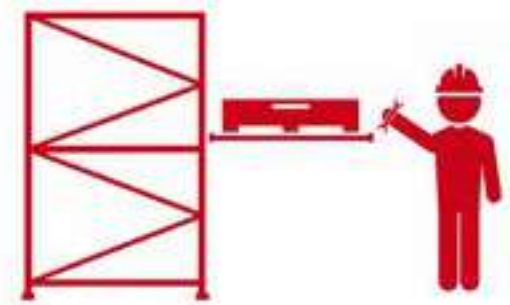

# Pull-out units

When you need to pick parts directly from the pallet, pull-out units are the obvious choice according to us. Easy access to goods, whether it's manual picking or extremely heavy loads that require an overhead crane. Normally, pallets are handled on the units, but a steel shelf panel allows for storing smaller items like plastic bins or cardboard boxes directly on the unit. Access and organization should be easy in a warehouse or production flow.

Delivered assembled  
and function-tested!

## CHOOSE BETWEEN

Beam-mounted  
Floor-mounted  
Upright-mounted  
Wide  
Electric

*Ergonomically  
smart choice!*



# Circle your choices Help choosing the right one

Find out the true weight of your palletized goods to select the right load capacity. Load capacity refers to the load distributed over the entire surface. Choose the pallet size and from which direction you want to handle the goods, short side or long side. Choose how you load; from the back or front. Finally, select the pull-out capacity. What you choose here depends on how the goods will be handled and how large they are.

We help you find the right solutions!

[INFO@SMARTSTORING.SE](mailto:INFO@SMARTSTORING.SE)  
+46 304 80 90 80

## 1. Load capacity



150



200



300



600



800



1000



1200



1500

## 2. Pallet size & orientation



**EUR**

Short-side handled pallet  
800 x 1200 mm (W x L)

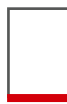

**FIN**

Short-side handled pallet  
1000 x 1200 mm (W x L)



**HMU**

Short-side handled with reinforced corners  
securing a wire mesh container  
800 x 1200 mm (W x D)



**EUR-L**

Long-side handled pall  
1200 x 800 mm (W x L)



**FIN-L**

Long-side handled pall  
1200 x 1000 mm (W x L)



**HMU-L**

Long-side handled with reinforced corners  
securing a wire mesh container  
1200 x 800 mm (W x D)





SEPARATE TRUCK TRAFFIC FROM PEDESTRIAN TRAFFIC FOR INCREASED SAFETY AND EFFICIENCY, REDUCING THE RISK OF ACCIDENTS.

Use single-sided racks.  
 Choose rear-loaded units.  
 Load from one side.  
 Pull out and pick from the other side.

### 3. Loading

**FRONT-LOADED**  
 Loading and picking from the same side

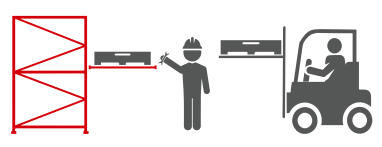

**REAR-LOADED**  
 Loading from the back

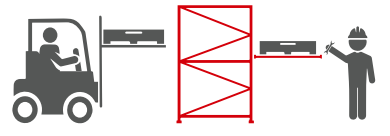

### 4. Pull-out capacity



**70% PULL-OUT CAPACITY**  
 In most cases, a 70% extension is adequate to access all goods.



**100% PULL-OUT CAPACITY**  
 100% extension offer full access to small goods also when placed far back on a shelf or pallet. It's also perfect when handling heavy goods with an overhead crane.



**70% PULL-OUT CAPACITY**  
**2-WAY UNIT**  
 The unit can be pulled out in two directions, allowing access from both sides of the pallet rack



# Beam-mounted pull-out units

Beam-mounted pull-out units are installed on the beams within a pallet rack. The unit's lower frame is securely attached to the rear load beam, while the upper frame runs on the lower frame with the help of ball bearings. Typically, pallets are handled on these units, but the addition of a steel shelf panel allows for the storage of smaller items like plastic bins or cardboard boxes directly on the unit.



**100%**  
**PULL-OUT CAPACITY**  
**1-WAY UNIT**



**70%**  
**PULL-OUT CAPACITY**  
**1-WAY UNIT**  
**2-WAY UNIT**

**UNITS WITH AN 'OPEN FRAME'**  
are designed for pallets.

**UNITS WITH STEEL SHELF PANELS**  
are well-suited for storing plastic bins, cardboard boxes, and loose objects.

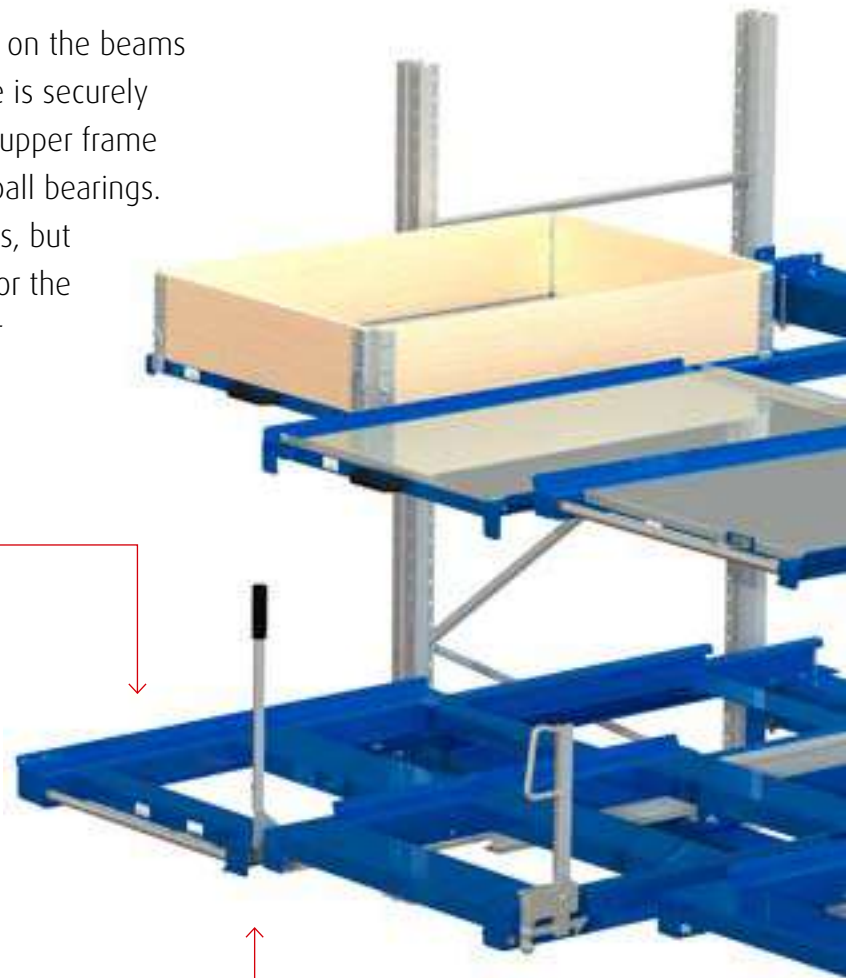

As **ACCESSORIES**, there are side handles with or without the Easy Action™ function, steel shelf panels, pallet stoppers, feet and safety locks.

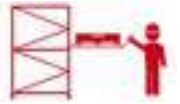

Best in test!

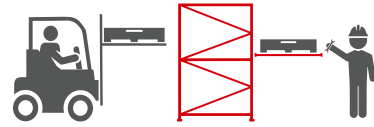

**WE OFFER UNITS DESIGNED FOR EITHER FRONT OR REAR LOADING**

**AUTOMATICALLY LOCKS**  
in the retracted position



**LOAD CAPACITY UP TO 1500 KG**

Customized sizes

Delivered **FULLY ASSEMBLED** and **FUNCTION-TESTED**, ready for installation!

**EASY TO INSTALL**

- secured to the rear beam of the pallet rack with 4 screws

**COMPATIBLE** with nearly all pallet racks available on the market



Double front ball bearings ensure a low profile and guarantee **SMOOTH OPERATION UNDER HIGH LOADS**

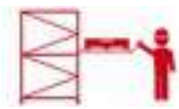

In most cases, 70% extension is adequate to access all goods.

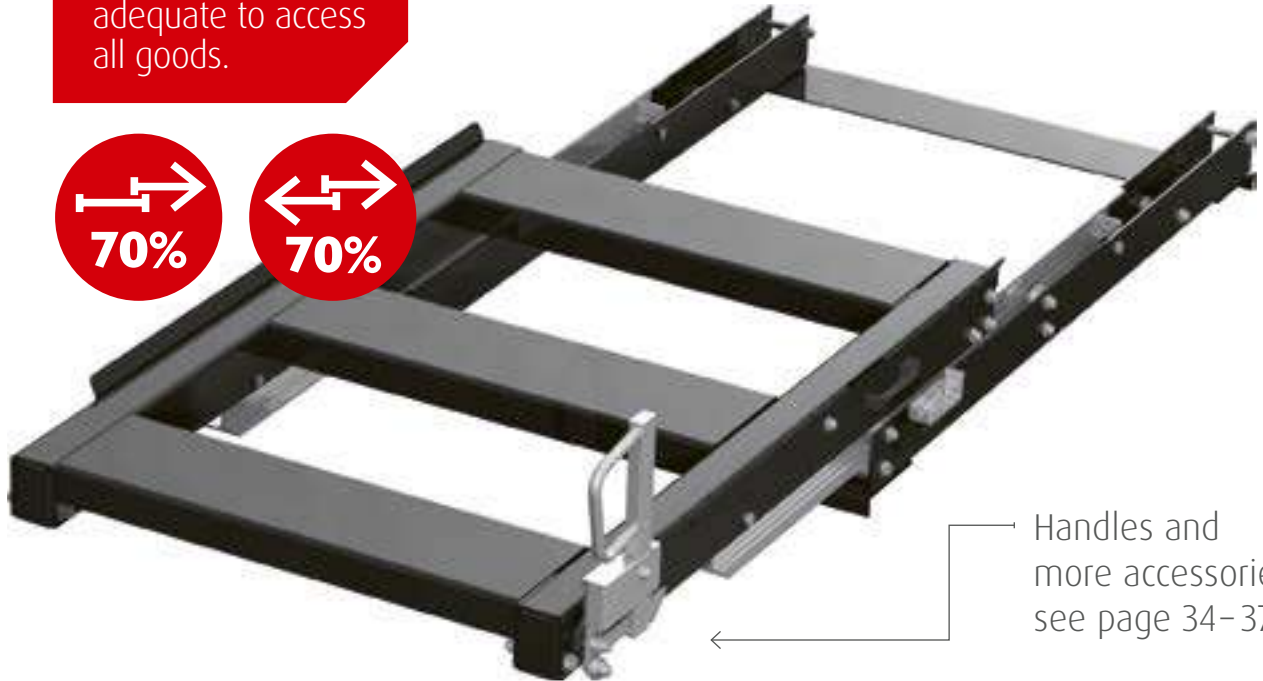

Handles and more accessories, see page 34-37

**Beam-mounted 70% pull-out capacity**

*Bestsellers!*



PALLET SIZE	LOADING	ORIENTATION	300 KG	600 KG	800 KG	1000 KG	1200 KG	1500 KG	600 KG	800 KG
EUR	Front-loaded	Short-side handled	11 301-0	11 601-0	11 801-0	11 1001-0	11 1201-0	11 1501-0	11 601-2	11 801-2
EUR	Rear-loaded	Short-side handled	11 302-0	11 602-0	11 802-0	11 1002-0	11 1202-0	11 1502-0		
EUR-L	Front-loaded	Long-side handled		11 605-0	11 805-0	11 1005-0				
EUR-L	Rear-loaded	Long-side handled		11 606-0	11 806-0	11 1006-0				
FIN	Front-loaded	Short-side handled		11 603-0	11 803-0	11 1003-0	11 1203-0	11 1503-0	11 603-2	11 803-2
FIN	Rear-loaded	Short-side handled		11 604-0	11 804-0	11 1004-0	11 1204-0	11 1504-0		
FIN-L	Front-loaded	Long-side handled		11 607-0	11 807-0	11 1007-0				
FIN-L	Rear-loaded	Long-side handled		11 608-0	11 808-0	11 1008-0				
HMU (wire mesh container)	Front-loaded	Short-side handled			11 809-0	11 1009-0	11 1209-0	11 1509-0		11 809-2
HMU (wire mesh container)	Rear-loaded	Short-side handled			11 810-0	11 1010-0	11 1210-0	11 1510-0		
HMU-L (wire mesh container)	Front-loaded	Long-side handled			11 811-0	11 1011-0	11 1211-0	11 1511-0		
HMU-L (wire mesh container)	Rear-loaded	Long-side handled			11 812-0	11 1012-0	11 1212-0	11 1512-0		
EUR 1/2 pallet	Front-loaded	Front-side handled		11 613-0						

We help you find the right solutions!  
**INFO@SMARTSTORING.SE**  
**+46 304 80 90 80**

In order to extend and access from both sides, choose the two-way function!



A 100% extension is ideal for accessing smaller goods positioned far back on a pallet or handling large, heavy parts with an overhead crane.

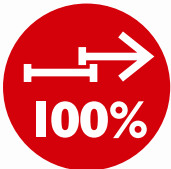

Steel shelf panel and more accessories, see page 34-37

**Beam-mounted 100% pull-out capacity**



PALLET SIZE	LOADING	ORIENTATION	300 KG	600 KG	800 KG	1000 KG
EUR	Front-loaded	Short-side handled	11 301-1	11 601-1	11 801-1	11 1001-1
EUR	Rear-loaded	Short-side handled	11 302-1	11 602-1	11 802-1	11 1002-1
EUR-L	Front-loaded	Long-side handled	11 305-1	11 605-1	11 805-1	11 1005-1
EUR-L	Rear-loaded	Long-side handled	11 306-1	11 606-1	11 806-1	11 1006-1
FIN	Front-loaded	Short-side handled	11 303-1	11 603-1	11 803-1	11 1003-1
FIN	Rear-loaded	Short-side handled	11 304-1	11 604-1	11 804-1	11 1004-1
FIN-L	Front-loaded	Long-side handled	11 307-1	11 607-1	11 807-1	11 1007-1
FIN-L	Rear-loaded	Long-side handled	11 308-1	11 608-1	11 808-1	11 1008-1
HMU (wire mesh container)	Front-loaded	Short-side handled			11 809-1	11 1009-1
HMU (wire mesh container)	Rear-loaded	Short-side handled			11 810-1	11 1010-1
HMU-L (wire mesh container)	Front-loaded	Long-side handled			11 811-1	11 1011-1
HMU-L (wire mesh container)	Rear-loaded	Long-side handled			11 812-1	11 1012-1
EUR 1/2 pallet	Front-loaded	Front-side handled		11 613-1		

*Bestseller!*

**Beam-mounted Manual handling**



PALLET SIZE	LOADING	ORIENTATION	200 KG, 70%	200 KG, 100%	200 KG, 70%
EUR	Front-loaded	Short-side handled	11 201-0	11 201-1	11 201-2
EUR	Front-loaded	Long-side handled	11 205-0	11 205-1	

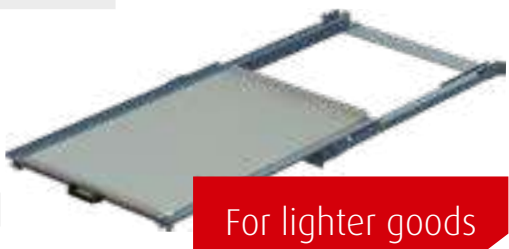

For lighter goods

The load surface consists of a galvanized steel shelf panel with folded edges, perfect for Euro boxes, cardboard boxes, tools, etc.

*Bestseller!*

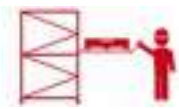

# Rotable pull-out unit

*Time saver!*

**1. PULL OUT**

**2. ROTATE**

**3. PUSH IN!**

A patent pending  
innovation by  
Smart Storing!

In warehouse operations, especially in food distribution, the rapid picking of goods is crucial. Pickers reach as far as possible onto the pallet, and when their reach is exhausted, turning the pallet becomes necessary. Traditionally, this involved using a forklift to bring down the pallet, driving the forklift around to the opposite side, and then lifting the pallet back up.

Now, with Smart Storing's beam-mounted pull-out unit R1, flipping the pallet can be achieved in a single motion. This efficient capability saves a significant amount of time.







Watch how it works!



Pick from the pallet as far as you can reach.



Pull out and turn the pallet.



Push back in and continue to pick!

**NEW!**

**FASTER ACCESS  
TO THE WHOLE  
PALLET**



### R1 - Rotatable pull-out unit

Introducing our Rotatable pull-out unit - With its smooth rotation mechanism, you can effortlessly reach every item without the need for a forklift. Beam-mounted, front or rear-loaded and short-side handled.

ART. NO.

11 601-1-R1



600 kg



100%

SPECIFICATION

for EUR-pallet

We help you find the right solutions!

[INFO@SMARTSTORING.SE](mailto:INFO@SMARTSTORING.SE)  
+46 304 80 90 80

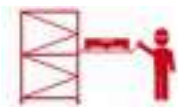

### Front pallet stop

Two metal plates at the front edge of each side of the unit, serving as stops for the pallet when it's loaded from the rear. *These front pallet stops are welded onto the unit and cannot be ordered separately.*

ART. NO.	SPECIFICATION
11 001-40	Front edge stops left & right for beam-mounted unit

### Antiskid tape

Four pieces of self-adhesive tape at each corner. The tape has a rough surface which grips the pallet and prevents it from sliding around when empty or lightly loaded.

ART. NO.	SPECIFICATION
11 002-0	Set of 4 pcs

### Rear pallet stops

Mounted at the rear to prevent the pallet from sliding backward when the unit is pushed in.

ART. NO.	SPECIFICATION
11 001-00	Length 600 mm, edge height 30 mm

### Warning tape

The tape is placed on each side of the upper side profiles. The warning tape is yellow and black and visually warns others in the truck aisle that a unit is extended.

ART. NO.	SPECIFICATION
11 002-1	Height 30 mm



## MAKE YOUR BEAM-MOUNTED PULL-OUT UNIT INTO A FLOOR MODEL

Beam-mounted pull-out units can be directly mounted on the floor using low (35 mm) floor mounting brackets, which is ideal when utilizing a counterbalance forklift. Alternatively, they can be mounted on 150 mm high feet. Choosing feet is advantageous when using a stacker allowing the support wheels to roll under the unit and facilitating easy cleaning beneath it. Additionally, feet can offer ergonomic benefits by raising the picking height. With side handles at your preferred height and a foot pedal, you achieve an easily maneuverable unit.

### Foot-operated lock release catch

Recommended for units mounted near floor level. Complete kit with mounting details.

ART. NO.	SPECIFICATION
11 013-00	Foot-operated lock release catch for beam-mounted units



### Feet

This product enables you to mount beam units directly onto the floor. Feet are available in various heights. When using feet, there is space between the floor and the unit to accommodate the wheels of a pallet stacker, also referred to as a support-leg truck. Material: Galvanized steel.

ART. NO.	SPECIFICATION
12 150-08	Height 150 mm, 4 feet including mounting details, max 800 kg 100% and 1000 kg 70%
12 150-10	Height 150 mm, 4 feet including mounting details, for 1000 kg 100% and 1500 kg 70%



### Floor mounting profiles

For mounting close to the floor, these profiles are used on short- and long-side handled units, height only 35 mm. 2 pieces, including mounting details. Material: Galvanized steel.

ART. NO.	SPECIFICATION
12 035-10S	Short-side handled unit, max 1000 kg 70%
12 035-10L	Long-side handled unit, max 1000 kg 70%
12 035-15S	Short-side handled unit, for 1500 kg 70% or 1000 kg 100%





## Steel shelf panels

This accessory covers the top of the pull-out unit, allowing storage of plastic bins, cardboard boxes, production tooling, or loose items. It also provides the option to store pallets directly on the panel, offering flexible storage solutions. Material: Galvanized steel.

### ART. NO. SPECIFICATION

11 160-0	Fits short-side handled 300 kg 100% and 600 kg 70% or 100%
11 160-3	Fits short-side handled 600 kg 2-way
11 160-6	Fits long-side handled 300 kg and 600 kg
11 180-0	Fits short-side handled 800 kg 70% or 100% and 1000 kg 70%
11 180-6	Fits long-side handled 800 kg 70% or 100% and 1000 kg 70%



**NEW!**

When sprinkler systems are installed, there are often requirements for water permeability. Smart Storing's wire mesh kits is the solution! The wire mesh shelf replaces a metal sheet when you want to utilize the entire storage surface without pallets.

### ART. NO. SPECIFICATION

11 120-0N	Fits short-side handled 200 kg beam-mounted and CSU shelves 70%
11 120-1N	Fits short-side handled 200 kg beam-mounted and 150 kg CSU shelves 100%
11 160-0N	Fits short-side handled 300 kg 100% and 600 kg 70% or 100%



## Pallet collar kit BM

Store your items directly on the unit without the need for a pallet. A compact solution for manually handled goods. Suitable for pull-out units: 11 301-1, 11 601-0, 11 601-1.

### ART. NO. SPECIFICATION

11 160-80	Includes steel shelf panel, pallet collar with cut brackets, 2 front handles and extended grip for latch in inner position
-----------	--

## Handles for beam-mounted units

Most beam-mounted units can be equipped with vertical side handles. Models for pallet handling have integrated horizontal locking handles but are also prepared for the installation of standard vertical handles.

*Standard* handles are recommended when units are placed low.

*Easy Action™* handles are recommended for units with heavier goods. These side handles are great for low placement. *Easy Action™* handles have a lever function that facilitates the operator's handling. Delivered fully assembled on the selected unit.

### ART. NO. SPECIFICATION

11-12	Standard handle. Height 200 mm
11-13	Standard handle. Height 330 mm
11-15	Standard handle. Height 500 mm
11-17	Standard handle. Height 700 mm
11-19	Standard handle. Height 900 mm
11-23	Easy Action™ handle. Height 330 mm
11-25	Easy Action™ handle. Height 500 mm
11-27	Easy Action™ handle. Height 700 mm
11-29	Easy Action™ handle. Height 900 mm



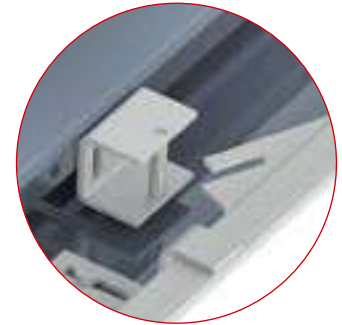
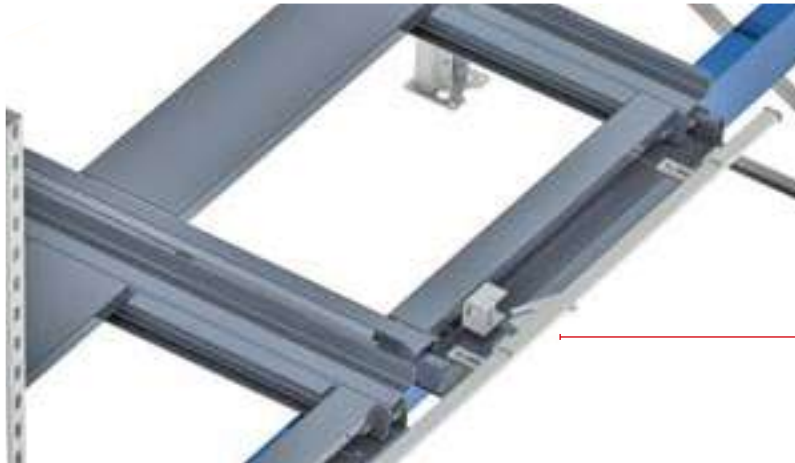
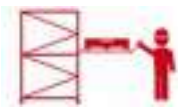

Rear-mounted safety lock that has just left the lock

## Safety lock – Beam-mounted pull-out units

A pull-out unit locking system avoids the danger of the cross-beam being overloaded. The lock is available for two, three or four pallet-width bays and locks one section at the time. When one unit is pulled out, the others are locked. Normally this lock is placed at the back. We also have a lock that is placed under the unit; this is typically used when there isn't enough room behind, for example if you have double pallet racks, or if you load from the rear.

ART. NO.	UNDER-MOUNTED SAFETY LOCK SPECIFICATION
11 2KU-0670	Safety lock for 2 pull-out units, 600 kg, 70%
11 2KU-0870	Safety lock for 2 pull-out units, 800 kg, 70%
11 2KU-1070	Safety lock for 2 pull-out units, 1000 kg, 70%
11 3KU-0670	Safety lock for 3 pull-out units, 600 kg, 70%
11 3KU-0870	Safety lock for 3 pull-out units, 800 kg, 70%
11 3KU-1070	Safety lock for 3 pull-out units, 1000 kg, 70%
11 4KU-0670	Safety lock for 4 pull-out units, 600 kg, 70%
11 4KU-0870	Safety lock for 4 pull-out units, 800 kg, 70%
11 4KU-1070	Safety lock for 4 pull-out units, 1000 kg, 70%

ART. NO.	REAR-MOUNTED SAFETY LOCK SPECIFICATION
11 2K-0670	Safety lock for 2 pull-out units, 600 kg, 70%
11 2K-0870	Safety lock for 2 pull-out units, 800 kg, 70%
11 2K-1070	Safety lock for 2 pull-out units, 1000 kg, 70%
11 2K-06100	Safety lock for 2 pull-out units, 600 kg, 100%
11 2K-08100	Safety lock for 2 pull-out units, 800 kg, 100%
11 2K-10100	Safety lock for 2 pull-out units, 1000 kg, 100%
11 3K-0670	Safety lock for 3 pull-out units, 600 kg, 70%
11 3K-0870	Safety lock for 3 pull-out units, 800 kg, 70%
11 3K-1070	Safety lock for 3 pull-out units, 1000 kg, 70%
11 3K-06100	Safety lock for 3 pull-out units, 600 kg, 100%
11 3K-08100	Safety lock for 3 pull-out units, 800 kg, 100%
11 3K-10100	Safety lock for 3 pull-out units, 1000 kg, 100%
11 4K-0670	Safety lock for 4 pull-out units, 600 kg, 70%
11 4K-0870	Safety lock for 4 pull-out units, 800 kg, 70%
11 4K-1070	Safety lock for 4 pull-out units, 1000 kg, 70%
11 4K-06100	Safety lock for 4 pull-out units, 600 kg, 100%
11 4K-08100	Safety lock for 4 pull-out units, 800 kg, 100%
11 4K-10100	Safety lock for 4 pull-out units, 1000 kg, 100%



Smart Storing's safety lock makes sure only on unit at a time is extracted!

## Lock in extended position

With a light load, there is a possibility that the pull-out unit may unintentionally slide back in. This lock is designed to secure the pull-out unit in the extended position, something that is also desired when loading with an overhead crane.

ART. NO.	SPECIFICATION
11 004-0270	Lock for 200 kg 70%, 3 pieces including mounting kit
11 004-0370	Lock for 300 kg 70%, 3 pieces including mounting kit
11 004-0670	Lock for 600 kg 70%, 3 pieces including mounting kit
11 004-0870	Lock for 800 kg 70%, 3 pieces including mounting kit
11 004-1070	Lock for 1000 kg 70%, 4 pieces including mounting kit and locking handle
11 004-02100	Lock for 200 kg 100%, 3 pieces including mounting kit
11 004-03100	Lock for 300 kg 100%, 3 pieces including mounting kit
11 004-06100	Lock for 600 kg 100%, 3 pieces including mounting kit
11 004-08100	Lock for 800 kg 100%, 3 pieces including mounting kit
11 004-10100	Lock for 1000 kg 100%, 4 pieces including mounting kit and locking handle





## Mounting kit

All the essentials for fitting beam-mounted units to your racking are included. The kit includes 2 pre-drilled mounting plates, 4 bolts, 4 locking nuts, and 4 washers. Please note, for units with a load capacity of 1000kg or more, use fitting kits with M10 bolts. *State beam height on order to ensure we include the correct kit!*

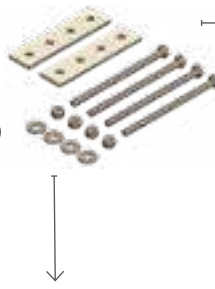

## INSTALLATION IS EASY!

Beam-mounted units are secured with four bolts in the rear beam. The exception is the two-way units, which are secured both at the front and rear.

ART. NO.	SPECIFICATION
24-M8-100H	For beam heights up to 75 mm
24-M8-120H	For beam heights up to 95 mm
24-M8-140H	For beam heights up to 115 mm
24-M8-160H	For beam heights up to 135 mm
24-M8-180H	For beam heights up to 155 mm
24-M8-200H	For beam heights up to 175 mm
24-M10-100H	For beam heights up to 70 mm
24-M10-120H	For beam heights up to 90 mm
24-M10-140H	For beam heights up to 110 mm
24-M10-160H	For beam heights up to 130 mm
24-M10-180H	For beam heights up to 150 mm
24-M10-200H	For beam heights up to 170 mm

A mounting kit is included with every beam-mounted unit



## THE MINIMUM LOAD CAPACITY PER BEAM PAIR

When a pull-out unit is extended, the front beam experiences higher loading than normal, while the rear beam encounters lifting force. For safety reasons, the front beam must be dimensioned to handle this increased loading.

Refer to the table below for the required load capacity.

WEIGHT & EXTENSION CAPACITY	1	2	3
	PALLET SPACE	PALLET SPACES	PALLET SPACES
	<b>MINIMUM WEIGHT CAPACITY/SUPPORT BEAMS PAIR</b>		
200 kg 70%	512 kg	744 kg	976 kg
200 kg 100%	643 kg	886 kg	1129 kg
300 kg 100%	963 kg	1326 kg	1689 kg
600 kg 70%	1475 kg	2110 kg	2745 kg
600 kg 100%	1866 kg	2532 kg	3198 kg
800 kg 70%	1973 kg	2826 kg	3679 kg
800 kg 100%	2493 kg	3386 kg	4279 kg
1000 kg 70%	2486 kg	3572 kg	4658 kg
1000 kg 100%	3098 kg	4196 kg	5297 kg
1200 kg 70%	2970 kg	4260 kg	5550 kg
1500 kg 70%	3707 kg	5314 kg	6921 kg

## Important safety information

The pallet rack must be securely bolted to the floor, following the manufacturer's instructions.

Rear cross beam must be bolted to the pallet racking uprights (minimum dimension M8).

The pull-out unit must be bolted to the rear cross-beam with 4 bolts according to the installation instructions.

Ensure that each pair of cross beams has a load capacity not less than specified in the chart on the left.

Only one pull-out unit in each section (pair of cross beams) may be pulled out at a time.

For pull-out units in multiple levels above each other – only one pull-out unit may be pulled-out at a time.

Each pull-out unit is marked with a separate label showing the maximum evenly distributed load.

The pull-out unit must be closed immediately after use – verify that it is locked!

*For full information, be sure to read product data sheets and installation manuals.*

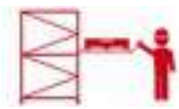

# Floor-mounted pull-out units

Floor-mounted pull-out units fit under pallet racks and are compatible with almost any type of pallet racking, but can also be used as standalone units. Being able to pull out the units from the pallet rack enables safe and easy access to stored products.



**85%**  
**PULL-OUT CAPACITY**

**STRONG AND PRACTICAL DESIGN**

**EASY TO INSTALL**

Bolt kit for concrete floor included!

**CAN BE LOADED WITH:**

- PALLET JACK
- STACKER
- FORKLIFT

**AUTOMATICALLY LOCKS**

in the retracted position

You have the **OPTION** to choose side handles, available with or without the Easy Action™ feature, foot-operated locks, and removable handles.





The best advantages!

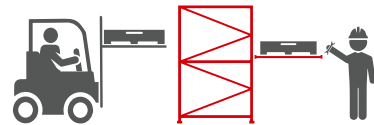

**WE OFFER UNITS  
DESIGNED FOR EITHER  
FRONT OR REAR LOADING**



**LOAD CAPACITY  
UP TO 1500 KG**

**GUIDE BEARINGS** ensure that **THE UNITS STAY ALIGNED** when pulled out and can be effortlessly pushed back in

Guide bearings also **PROTECT THE UNIT FROM BEING DISLODGED** in the event of side impacts

**LOW PROFILE!**

Only 72 mm high. Easy to load with a traditional pallet jack

Saves valuable vertical space = optimize picking levels at ergonomic heights

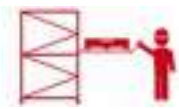

**LOW PROFILE**  
Saves space!

**85%**



Front-loaded, short-side handled, floor-mounted unit.

More accessories, see next page



Front-loaded, long-side handled, floor-mounted unit.  
HMU (for wire mesh container) - Equipped with corner plates that keep a wire mesh container in place.



Rear-loaded, short-side handled, floor-mounted unit.  
For 1500 kg load - Extra strong parts and additional wheel support bar.

**Floor-mounted units**

*Bestsellers!*

**85%**

PALLET SIZE	LOADING	ORIENTATION	800 KG	1000 KG	1200 KG	1500 KG
EUR	Front-loaded	Short-side handled	13 801	13 1001	13 1201	13 1501
EUR	Rear-loaded	Short-side handled	13 802	13 1002	13 1202	13 1502
EUR-L	Front-loaded	Long-side handled	13 805	13 1005	13 1205	13 1505
EUR-L	Rear-loaded	Long-side handled	13 806	13 1006	13 1206	13 1506
FIN	Front-loaded	Short-side handled	13 803	13 1003	13 1203	13 1503
FIN	Rear-loaded	Short-side handled	13 804	13 1104	13 1204	13 1504
FIN-L	Front-loaded	Long-side handled	13 807	13 1007	13 1207	13 1507
FIN-L	Rear-loaded	Long-side handled	13 808	13 1008	13 1208	13 1508
HMU (wire mesh container)	Front-loaded	Short-side handled	13 809	13 1009	13 1209	
HMU (wire mesh container)	Rear-loaded	Short-side handled	13 810	13 1010	13 1210	
HMU-L (wire mesh container)	Front-loaded	Long-side handled	13 811	13 1011	13 1211	
HMU-L (wire mesh container)	Rear-loaded	Long-side handled	13 812	13 1012	13 1212	

**!**  
All floor-mounted models require a handle or foot lock for unit operation

Supplied with guide rails, floor stops for the handle lock, mounting kit for anchoring in concrete floor, and bracket for side handle with locking function in the retracted position.





## CONVERT A BEAM-MOUNTED UNIT INTO A FLOOR-MOUNTED MODEL

- If the floor surface is too uneven for the wheels.
- If the floor is not level.
- If you desire pull-out units to be positioned at a higher level to enhance picking ergonomics.
- If you require 100% pull-out capacity, even though 85% is often sufficient for full access.



For beam-mounted units, see page 30-31

For feet kits and other accessories, see page 34

We help you find the right solutions!

[INFO@SMARTSTORING.SE](mailto:INFO@SMARTSTORING.SE)  
+46 304 80 90 80

### Handles for floor-mounted units

*Bestsellers!*

Handle or foot-operated release catch is required for all floor-mounted pull-out units and should be specified when ordering. The standard handle is suitable for most models, while the Easy Action™ handle is recommended for the heavier units - or if you simply want to be especially kind to your operators!

*The handles are integrated with safety locks that automatically keep the units in place when they are in the retracted position. This is especially important when you want the unit to stay still when loading it, or not to slide out on its own in the aisle!*

ART. NO.	SPECIFICATION
13-15	Standard handle, 500 mm
13-17	Standard handle, 700 mm
13-19	Standard handle, 900 mm
13-25	Easy Action™-handle, 500 mm
13-27	Easy Action™-handle, 700 mm
13-29	Easy Action™-handle, 900 mm
13-35	Detachable handle including foot lock, 500 mm
13-37	Detachable handle including foot lock, 700 mm
13-39	Detachable handle including foot lock, 900 mm
13-4	Foot lock



#### EASY ACTION™ -HANDLE

A clever mechanism enables the handle to function like a lever, reducing the force required to extract a heavy pallet.

**WORKS LIKE A LEVER** for best ergonomics!



#### FOOT-OPERATED RELEASE CATCH

Used with, for example, HMU models when a side handle is not suitable. Delivered complete with floor stop.



#### REMOVABLE HANDLE

Suitable if you have material protruding beyond the pallet, and the handle gets in the way during loading or unloading. Delivered complete with floor stop and foot lock.



#### STANDARD HANDLE

A handle with a built-in locking function that keeps the floor-mounted model in place when you load it. Delivered complete with a floor stop.

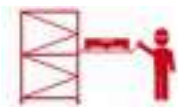

### Custom colour choice

Our standard colours are graphite grey RAL 7024 and blue RAL 5010. Personalize your order by selecting colours that match your preferences. We are happy to supply products in any combination of RAL colours for an extra cost and a slightly extended lead time.

Choose your own colour!  
**ONE OF OUR MOST POPULAR OPTIONS!**

ART. NO.	SPECIFICATION
RALSTART	Quoted upon request



### Steel shelf panels

An accessory that covers the top of the pull-out unit. With this, you can store plastic bins, cardboard boxes, production tooling or loose items. It's also possible to store pallets directly on the steel shelf panel, providing flexible storage. Material: Galvanized steel.

ART. NO.	SPECIFICATION
13 180-0	Steel shelf panel for short-side handled EUR unit
13 180-6	Steel shelf panel for long-side handled EUR unit



An extra pallet support bar with an extra wheel is necessary together with the steel shelf panel

### Extra pallet support bar

To enhance the load-bearing capacity, add a pallet support bar that includes an extra wheel. This accessory provides crucial support for the pallet's center skid during high loads, particularly beneficial when using plastic pallets or when placing a steel shelf panel on top.

ART. NO.	SPECIFICATION
13 001-0	Extra support bar for short-side handled EUR & FIN unit
13 001-1	Extra support bar for long-side handled EUR unit
13 001-1F	Extra support bar for long-side handled FIN unit

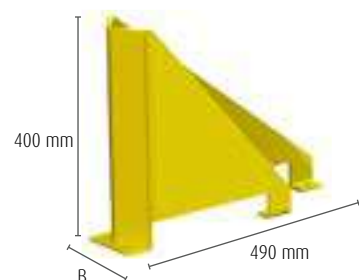

### Antiskid tape

Four pieces of self-adhesive tape at each corner. The tape has a rough surface which grips the pallet and prevents it from sliding around when empty or lightly loaded.



ART. NO.	SPECIFICATION
11 002-0	Set of 4 pcs

### Upright protectors Smart 400

Standard upright protectors are often bulky and might limit the inside width so floor-mounted pull-out units will not fit. The slim upright protector Smart 400 will solve this problem! Height 400 mm, depth 490 mm. Powder coated yellow.

ART. NO.	SPECIFICATION
13 401249	Width 120 mm (for post width 80 - 100 mm)
13 401349	Width 130 mm (for post width 90 - 110 mm)
13 401549	Width 150 mm (for post width 110 - 130 mm)



Supplement with pallet collar dividers, see page 114.

### Pallet collar kit

By storing small items directly on your floor-mounted pull-out unit, without a pallet, you can save even more space in height. *The pallet collar can be complemented with pallet collar dividers. See page 114 for Pallet Accessories.*

ART. NO.	SPECIFICATION
13 180-80	Pallet collar with cut brackets, steel shelf panel and extra support bar



**SAVE ASSEMBLY TIME!**  
Mark holes easily and accurately without measuring!

### Installation template

Steel plate with handles and predrilled holes. This accessory is a huge time saver when drilling the holes in the floor to receive the expanding bolts to secure FM units. Simply line up as many templates as you need - either 2 or 3 depending on how many pallet places there are between the uprights in your rack - and mark the holes easily and accurately - no need to measure!

ART. NO.	SPECIFICATION
13-MP	Installation template, specify the article number of the floor model to be used for the template when ordering

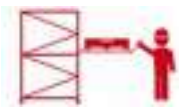

# Trojka Pull-out shelving

Smart Storing's Trojka is a floor-mounted pull-out unit with a 3-sided shelving. This solution is cost-effective and allows for a lot of storage on a small floor space. The unit is specially designed for third-party logistics handling lighter items. It is ergonomic and easy to use, with a wide range of practical accessories.

We help you find the right solutions!

[INFO@SMARTSTORING.SE](mailto:INFO@SMARTSTORING.SE)  
+46 304 80 90 80



**85%**  
**PULL-OUT CAPACITY**

*For lighter items!*





**NEW!**

**ACCESS FROM  
THREE DIFFERENT  
DIRECTIONS!**



**LOAD CAPACITY  
800 OR 1500 KG PER UNIT  
70 OR 200 KG PER SHELF**

Handles included!

Choose up to **9 SHELVES**

**ACCESSORIES** to customize  
to your needs



The top can also be used for storage



1500







800



Bins that fit the shelves, see page 118 - 119

### Trojka - Pull-out shelving 1500 kg

Automatically locks in the retracted position. Side handle, foot lock, and mounting kit for concrete floor included. Shelf size width 750 mm and depth 400 mm. Weight capacity 200 kg per shelf.

ART. NO.	 KG					SPECIFICATION
65 131500-03	1500 kg per unit	85%	889 mm	1374 mm	1924 mm	3 shelves per side
65 131500-04	1500 kg per unit	85%	889 mm	1374 mm	1924 mm	4 shelves per side
65 131500-05	1500 kg per unit	85%	889 mm	1374 mm	1924 mm	5 shelves per side
65 131500-06	1500 kg per unit	85%	889 mm	1374 mm	1924 mm	6 shelves per side
65 131500-07	1500 kg per unit	85%	889 mm	1374 mm	1924 mm	7 shelves per side
65 131500-08	1500 kg per unit	85%	889 mm	1374 mm	1924 mm	8 shelves per side



**SHELF**

Depth 400 mm  
 Width 750 mm  
 Load capacity up to 200 kg/shelf

When using 8 shelves, you get  
**19.2 METERS OF SHELF SPACE  
 ON ONE SINGLE PALLET SPACE**

**HANDLES INCLUDED!**

**THE PULL-OUT UNIT IS FULLY ASSEMBLED** and the shelving is assembled in place with simple assembly in a few steps



**FOOT-OPERATED RELEASE CATCH**





Automatically locks and is easily released with a foot press



**SHELF DIVIDERS ARE AVAILABLE AS ACCESSORIES**  
 Contact us for more information

**Trojka – Pull-out shelving  
 800 kg**

Automatically locks in the retracted position. Side handle, foot lock, and mounting kit for concrete floor included. Shelf size width 750 mm and depth 400 mm. Weight capacity 70 kg per shelf.

ART. NO.	 800 kg per unit	 85%	 WIDTH	 DEPTH	 HEIGHT	SPECIFICATION
65 130800-03	800 kg per unit	85%	889 mm	1374 mm	1924 mm	3 shelves per side
65 130800-04	800 kg per unit	85%	889 mm	1374 mm	1924 mm	4 shelves per side
65 130800-05	800 kg per unit	85%	889 mm	1374 mm	1924 mm	5 shelves per side
65 130800-06	800 kg per unit	85%	889 mm	1374 mm	1924 mm	6 shelves per side
65 130800-07	800 kg per unit	85%	889 mm	1374 mm	1924 mm	7 shelves per side
65 130800-08	800 kg per unit	85%	889 mm	1374 mm	1924 mm	8 shelves per side

We help you find the right solutions!  
**INFO@SMARTSTORING.SE**  
**+46 304 80 90 80**

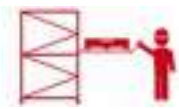

# Wide pull-out units

Wide beam-mounted pull-out units are suitable for storing items such as long goods and sheet material. As standard, they are available in three widths, three load capacities, and with 70% or 100% pull-out capacity. Mount the pull-out units in your regular pallet racking, and you

have a cost-effective and practical storage module.

We help you find the right solutions!

[INFO@SMARTSTORING.SE](mailto:INFO@SMARTSTORING.SE)  
+46 304 80 90 80



**100%  
PULL-OUT CAPACITY**



**70%  
PULL-OUT CAPACITY**

Handles **FLAT MATERIAL  
UP TO 2.5 M X 1.25 M**

Handles **LONG GOODS  
UP TO 2.5 METERS**

**STEEL SHELF PANELS** ←  
available as an accessory







*Long or sheet material!*



**CAN BE COMBINED WITH OTHER PULL-OUT UNITS**, such as for pallet handling, allowing materials of different types and sizes needed for the same process to be stored together.



**LOAD CAPACITY UP TO 1600 KG**

Compact storage with up to **6 LEVELS**

**ERGONOMIC** handling height

The material is loaded in a bundle or piece by piece, with or without packaging. It's typically manually picked or handled using some form of overhead crane.

Can be mounted directly on the floor with the help of two feet kits, see page 34.

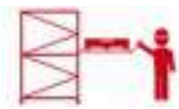

We can customize the size according to your preferences

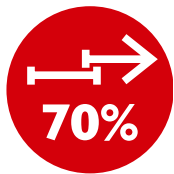

**Wide beam-mounted pull-out unit for sheet material**  
**70% pull-out capacity**

ART. NO.	 KG	WIDTH	STEEL SHELF PANEL THAT FITS
27 417-0	400 kg	1700 mm	27 120-17-0
27 421-0	400 kg	2100 mm	27 120-21-0
27 426-0	400 kg	2600 mm	27 120-26-0
27 1217-0	1200 kg	1700 mm	27 160-17
27 1221-0	1200 kg	2100 mm	27 160-21
27 1226-0	1200 kg	2600 mm	27 160-26
27 1617-0	1600 kg	1700 mm	27 180-17
27 1621-0	1600 kg	2100 mm	27 180-21
27 1626-0	1600 kg	2600 mm	27 180-26

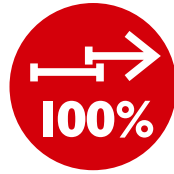

**Wide beam-mounted pull-out unit for sheet material**  
**100% pull-out capacity**

ART. NO.	 KG	WIDTH	STEEL SHELF PANEL THAT FITS
27 417-1	400 kg	1700 mm	27 121-17-1
27 421-1	400 kg	2100 mm	27 121-21-1
27 426-1	400 kg	2600 mm	27 121-26-1
27 617-1	600 kg	1700 mm	27 160-17
27 621-1	600 kg	2100 mm	27 160-21
27 626-1	600 kg	2600 mm	27 160-26
27 1217-1	1200 kg	1700 mm	27 160-17
27 1221-1	1200 kg	2100 mm	27 160-21
27 1226-1	1200 kg	2600 mm	27 160-26
27 1617-1	1600 kg	1700 mm	27 180-17
27 1621-1	1600 kg	2100 mm	27 180-21
27 1626-1	1600 kg	2600 mm	27 180-26



Wide units have a flat loading surface, allowing for some material to protrude if needed. These units can be equipped with folded edges and material dividers upon request.

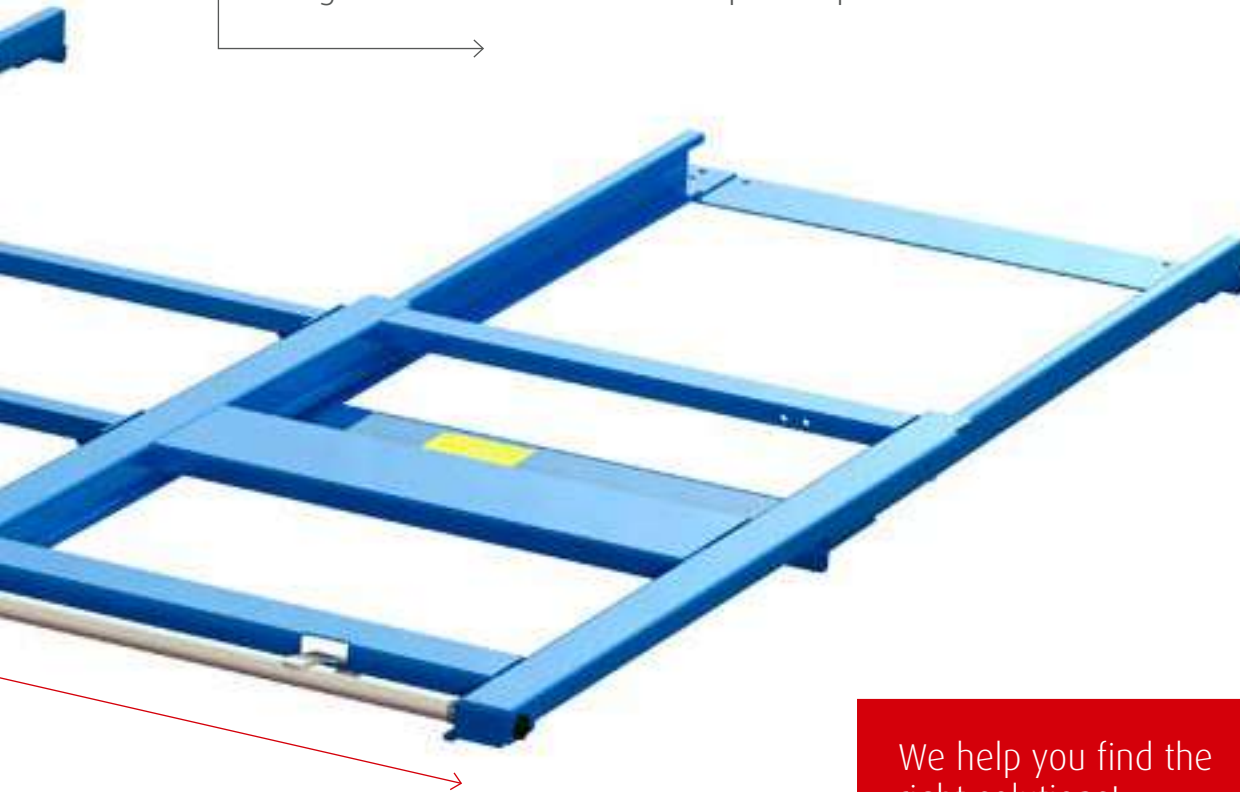

We help you find the right solutions!

[INFO@SMARTSTORING.SE](mailto:INFO@SMARTSTORING.SE)  
+46 304 80 90 80

## Steel shelf panels

This accessory covers the holes in the upper part of the pull-out unit. With the steel shelf panels, you can store soft materials such as rubber mats and panels without any part falling through. Material: Electro-galvanized steel sheet.

ART. NO.	FITS UNIT	NUMBER OF SHEETS
27 120-17-0	27 417-0	2 pcs
27 120-21-0	27 421-0	3 pcs
27 120-26-0	27 426-0	3 pcs
27 121-17-1	27 417-1	2 pcs
27 121-21-1	27 421-1	3 pcs
27 121-26-1	27 426-1	3 pcs
27 160-17	27 1217-0, 27 1217-1, 27 617-1	2 pcs
27 160-21	27 1221-0, 27 1221-1, 27 621-1	3 pcs
27 160-26	27 1226-0, 27 1226-1, 27 626-1	3 pcs
27 180-17	27 1617-0, 27 1617-1	2 pcs
27 180-21	27 1621-0, 27 1621-1	3 pcs
27 180-26	27 1626-0, 27 1626-1	3 pcs

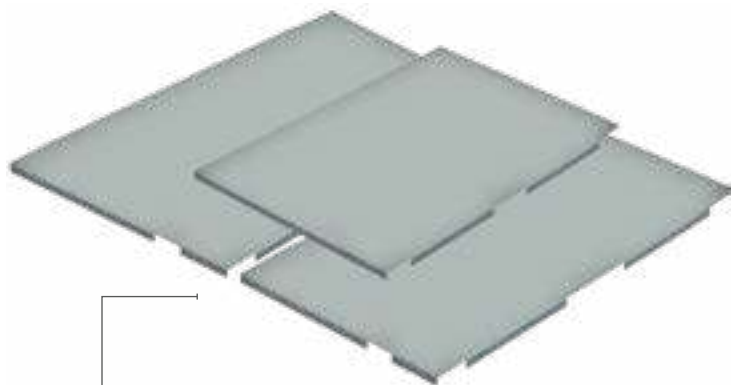

Steel shelf panel is an accessory and is ordered separately

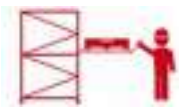

# Upright-mounted pull-out units

Upright-mounted pull-out units are directly attached to the uprights of the pallet racking system. The lower frame of the unit is bolted into the uprights, and the upper carriage slides out, carrying the load with it. This system is based on a rack system with a 950 mm opening between the posts and can offer a wide range of storage options in a small space.

When it comes to Pull-out Units designed for handling pallets in this system, we have specifically focused on achieving a low profile. This led us to position the rails and bearings on the sides of the extendable shelves.

For pull-out units intended for manually handled goods that do

We help you find the right solutions!

[INFO@SMARTSTORING.SE](mailto:INFO@SMARTSTORING.SE)  
+46 304 80 90 80

not involve pallet handling, they are available in various configurations and interior options. These units have a load capacity of up to 200 kg.



**100%**  
**PULL-OUT CAPACITY**



**70%**  
**PULL-OUT CAPACITY**



*Save space!*



**EASY TO INSTALL!**

**AUTOMATICALLY LOCKS  
IN THE RETRACTED POSITION**

Lock is released with the side handle



**LOAD CAPACITY  
UP TO 800 KG**

**STEEL SHELF PANEL** as an accessory for handling boxes, crates, or loose items

**USE ONE OR MULTIPLE SECTIONS  
SIDE BY SIDE**

A variety of materials needed in a production area can be stored and picked from this solution

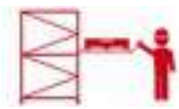

Optional front pallet stop and label holder. Contact us for further information!



### Upright-mounted pull-out unit – pallet handling

For short-side handled EUR pallets. With optional steel shelf panel it is also possible to store plastic bins and production tooling directly on the units. The loading area: width 834 mm x depth 1225 mm.



70% is the most economical choice. 100% is perfect for picking small goods far back on a pallet



ART. NO.

15 600-0

600 kg

70%

SPECIFICATION

Including connectors

15 600-1

600 kg

100%

Including connectors

15 802-1

800 kg

100%

Including connectors



### Upright-mounted pull-out unit with steel shelf panel

For goods loaded manually or with overhead crane. A steel shelf panel with 20mm high edges holds plastic bins, cardboard boxes and other items in place. Loading surface: width 805 mm x depth 1205 mm.



ART. NO.

15 201-1

150 kg

100%

SPECIFICATION

Including connectors and steel shelf panel with 20 mm edges

15 201-0

200 kg

70%

Including connectors and steel shelf panel with upturned edges

15 203-0

200 kg

70%

Including connectors and flat steel shelf panel for EUR pallet collar

FIFO flow shelves and more accessories for upright-mounted units, see page 90-95



### Standard rack

Each section can be filled with products according to your needs. A standard base section consists of 2 uprights and 2 top beams. The top beams hold the structure together but can also be used for buffer storage. An add-on section consists of 1 upright and 2 top beams. Expander bolts for concrete floors are included.

ART. NO.	HEIGHT	DEPTH	WIDTH	SPECIFICATION
15 20001101	2000 mm	1100 mm	950 mm	Standard base section
15 20001102	2000 mm	1100 mm	950 mm	Standard add-on section
15 25001101	2500 mm	1100 mm	950 mm	Standard base section
15 25001102	2500 mm	1100 mm	950 mm	Standard add-on section

Do you require a rack higher than 2500 mm? Get in touch with us, and we will provide you with a solution!



### Steel shelf panels

An accessory that covers the holes at the top of the pull-out unit. This allows you to store smaller items such as plastic bins or cardboard on the steel shelf panel. Material: Electro-galvanized sheet metal.

ART. NO.	SPECIFICATION
15 160-0	Thickness 1.5 mm with a downturned edge. Fits 15 600-0, 15 600-1
15 160-1	Thickness 3 mm with an upturned edge. Fits 15 600-0, 15 600-1
15 160-2	Thickness 3 mm with a downturned edge. Fits 15 600-0, 15 600-1

For storage of cardboard boxes, plastic bins, and loose items – add the steel shelf panel!



### Side handle

Pull-out units for pallets must be equipped with a side handle, making it easy to pull out the unit without having to bend too much. The height of the handle is determined by the clearance you have to the next level. The handle's design is made with consideration to avoid pinching injuries when loading goods. This solution has been developed in collaboration with the demanding automotive industry. Suitable for loads of up to 600 kg. *For higher loads, please contact us.*

ART. NO.	HEIGHT	SPECIFICATION
15-13	133 mm	Locking handle for close unit placement
15-25	250 mm	Locking handle for EUR pallet, 1 pallet collar, total height 345 mm
15-45	450 mm	Locking handle for EUR pallet, 2 pallet collars, total height 510 mm
15-65	645 mm	Locking handle for EUR pallet, 3 pallet collars, total height 735 mm
15-239	390 mm	Easy Action™-handle
15-255	550 mm	Easy Action™-handle

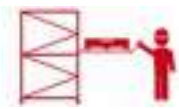

# Electric pull-out unit

With Smart Storing's e-EPU (Ergonomic electric pull-out unit), ergonomics can be further improved by eliminating all manual handling forces. The e-EPU is suitable for picking very heavy goods from pallets, often with the use of some type of overhead crane. It can also be used in robot cells and integrated into a fully automated picking solution

We help you find the right solutions!

[INFO@SMARTSTORING.SE](mailto:INFO@SMARTSTORING.SE)  
+46 304 80 90 80

**RADIO CONTROL**  
is available as an option

Operated through push buttons on a control panel

**LED INDICATOR**  
Programmable LED indicator displays multiple statuses, for example a fixed green light when the unit is in one of its end positions and flashes red when in motion.

**FRONT PLATE** with safety switch stops the unit upon activation







*For exceptionally heavy loads!*



**LOAD CAPACITY  
UP TO 1500 KG**

**STROKE LENGTH UP TO  
1150 MM**



Front- or rear-loaded

**CYCLE TIME 9 SECONDS**  
between end positions

**SOFT START AND STOP**

**EASY INSTALLATION**  
4 screws in a pallet rack  
and a power cable to a  
standard 230V AC outlet

 **EPU**  
Ergonomic Electric Pull-out Unit



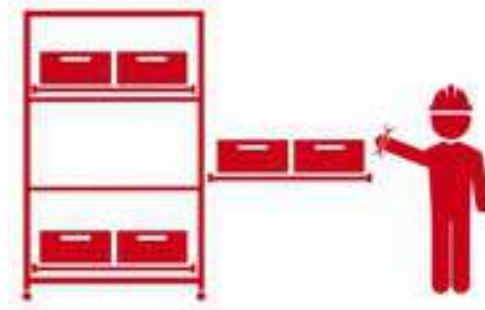
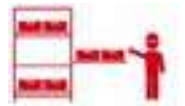

# Storage Modules

Simple, strong, and versatile, the basic structure comprises a sturdy steel frame with posts featuring a dense hole pattern, offering great adaptability. It is suitable for both permanent installations and can be transformed into mobile storage by equipping it with wheels and/or fork pockets

This product range is modular and offers various accessories and options, enabling customization to suit your specific needs. Its primary design focus is on smaller items that are manually handled.

## CHOOSE BETWEEN

- Compact Storage Units (CSU)
- CSU Light
- Mobile Pallet Units (MPU)
- Tool Storage Units (TSU)
- Pallet Storage Units (PSU)

Delivered assembled  
and function-tested!

*Possibilities!*

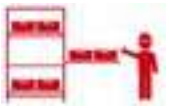

# Compact Storage Units

Compact Storage Units can accommodate a large number of easily accessible items within a footprint scarcely larger than a EUR pallet. These units are designed with a modular structure and offer a wide range of accessories for customization according to your specific needs. Achieve maximum storage efficiency in just one square meter.



**100%**  
**PULL-OUT CAPACITY**  
**1-WAY UNIT**



**70%**  
**PULL-OUT CAPACITY**  
**1-WAY UNIT**  
**2-WAY UNIT**

## **FLEXIBLE AND MODULAR DESIGN**

– possible to change your configuration later if needed

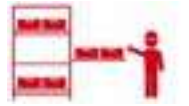

# Customize shelves to your specs!



← Up to  
**9 PULL-OUT SHELVES**  
per unit

**MANY ACCESSORIES FOR THE PULL-OUT SHELVES**, such as bins and frames with dividers

**NO INSTALLATION OR ASSEMBLY REQUIRED. READY TO USE!**

Fits on the floor in a pallet rack and **ONLY TAKES UP ONE PALLET SPACE**

**FULLY MOBILE** with optional wheels installed

**EASY TO MOVE** with a forklift using optional forklift pockets

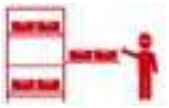

*Tips!*  
*Circle your choices*

## Help choosing the right one

The frames are available in two basic configurations: short-side handled and long-side handled, indicating on which side the pull-out shelves extend. The posts have pre-made holes at 30 mm centers for fitting shelves to your specifications.

We help you find the right solutions!

[INFO@SMARTSTORING.SE](mailto:INFO@SMARTSTORING.SE)  
**+46 304 80 90 80**

The shelves are covered with steel shelf panels made of strong galvanized steel plate and have 20 mm edges all around. The shelf size is 800 x 1200 mm, which is a standardized EUR measurement suitable for EUR bins and accessories for pallet collars. The shelves have a maximum load capacity of 150 kg with 100% pull-out or 200 kg with 70% pull-out.

**Standardized EUR measurements!**

Supplement with lots of smart accessories, see page 72–75



### SHELF LOCK

Prevents more than one shelf from being extended at the same time and ensures that the unit cannot tip over.

Useful if you are unable to bolt it to the floor.



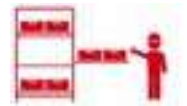

# 1. Frame



**SHORT-SIDE HANDLED**  
Loading surface  
804 x 1205 mm (W x L)

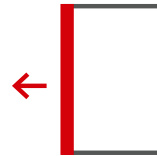

**LONG-SIDE HANDLED**  
Loading surface  
1205 x 804 mm (W x L)

# 2. Pull-out capacity



**70% PULL-OUT**

70% shelves are great for combining smaller boxes in the front and larger boxes in the back, offering numerous combination possibilities.



**100% PULL-OUT**

For maximum accessibility!  
100% shelves are the ideal choice for smaller boxes or compartments. If you are storing boxes with a depth of less than 400 mm, this option is the obvious choice.



**70% PULL-OUT  
2-WAY UNIT**

The unit can be pulled out in two directions, offering access from both sides. This 2-way function enables two users to utilize one unit for two different or similar items. Additionally, it proves advantageous in assembly lines; while one assembler picks from one side, another person can replenish with new material from the other side.

# 3. Shelves



**NUMBER OF SHELVES**    **CLEARANCE\***  
(Space between shelves)

3	395 mm
4	275 mm
5	215 mm
6	155 mm
7	125 mm
8	95 mm
9	95 mm



**NUMBER OF SHELVES**    **CLEARANCE\***  
(Space between shelves)

3	366 mm
4	246 mm
5	186 mm
6	126 mm
7	96 mm
8	66 mm
9	66 mm



**NUMBER OF SHELVES**    **CLEARANCE\***  
(Space between shelves)

3	402 mm
4	282 mm
5	222 mm
6	162 mm
7	132 mm
8	102 mm
9	102 mm

\*The tables display the clearance achieved with different numbers of shelves when standard-mounted with even distribution. Alternatively, shelves can be arranged in various individual combinations based on preference.

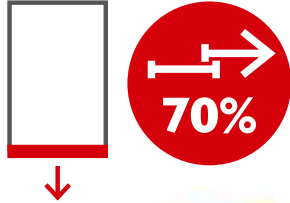
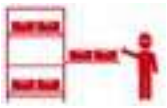

### Compact Storage Unit Short-side handled 70%

ART. NO.	KG	70%	WIDTH	DEPTH	HEIGHT	SPECIFICATION
22 111-0	200 kg per shelf	70% 1-way	880 mm	1273 mm	1560 mm	1 shelf
22 112-0	200 kg per shelf	70% 1-way	880 mm	1273 mm	1560 mm	2 shelves
22 113-0	200 kg per shelf	70% 1-way	880 mm	1273 mm	1560 mm	3 shelves
22 114-0	200 kg per shelf	70% 1-way	880 mm	1273 mm	1560 mm	4 shelves
22 115-0	200 kg per shelf	70% 1-way	880 mm	1273 mm	1560 mm	5 shelves
22 116-0	200 kg per shelf	70% 1-way	880 mm	1273 mm	1560 mm	6 shelves
22 117-0	200 kg per shelf	70% 1-way	880 mm	1273 mm	1560 mm	7 shelves
22 118-0	200 kg per shelf	70% 1-way	880 mm	1273 mm	1560 mm	8 shelves
22 119-0	200 kg per shelf	70% 1-way	880 mm	1273 mm	1560 mm	9 shelves
22 112-1	200 kg per shelf	70% 1-way	880 mm	1273 mm	1560 mm	2 shelves, shelf lock
22 113-1	200 kg per shelf	70% 1-way	880 mm	1273 mm	1560 mm	3 shelves, shelf lock
22 114-1	200 kg per shelf	70% 1-way	880 mm	1273 mm	1560 mm	4 shelves, shelf lock
22 115-1	200 kg per shelf	70% 1-way	880 mm	1273 mm	1560 mm	5 shelves, shelf lock
22 116-1	200 kg per shelf	70% 1-way	880 mm	1273 mm	1560 mm	6 shelves, shelf lock
22 117-1	200 kg per shelf	70% 1-way	880 mm	1273 mm	1560 mm	7 shelves, shelf lock
22 118-1	200 kg per shelf	70% 1-way	880 mm	1273 mm	1560 mm	8 shelves, shelf lock
22 119-1H	200 kg per shelf	70% 1-way	880 mm	1273 mm	1710 mm	9 shelves, shelf lock

*Bestsellers!*

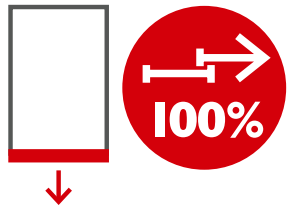

### Compact Storage Unit Short-side handled 100%

ART. NO.	KG	100%	WIDTH	DEPTH	HEIGHT	SPECIFICATION
22 121-0	150 kg per shelf	100%	880 mm	1273 mm	1560 mm	1 shelf
22 122-0	150 kg per shelf	100%	880 mm	1273 mm	1560 mm	2 shelves
22 123-0	150 kg per shelf	100%	880 mm	1273 mm	1560 mm	3 shelves
22 124-0	150 kg per shelf	100%	880 mm	1273 mm	1560 mm	4 shelves
22 125-0	150 kg per shelf	100%	880 mm	1273 mm	1560 mm	5 shelves
22 126-0	150 kg per shelf	100%	880 mm	1273 mm	1560 mm	6 shelves
22 127-0	150 kg per shelf	100%	880 mm	1273 mm	1560 mm	7 shelves
22 128-0	150 kg per shelf	100%	880 mm	1273 mm	1560 mm	8 shelves
22 129-0	150 kg per shelf	100%	880 mm	1273 mm	1560 mm	9 shelves
22 122-1	150 kg per shelf	100%	880 mm	1325 mm	1560 mm	2 shelves, shelf lock
22 123-1	150 kg per shelf	100%	880 mm	1325 mm	1560 mm	3 shelves, shelf lock
22 124-1	150 kg per shelf	100%	880 mm	1325 mm	1560 mm	4 shelves, shelf lock
22 125-1	150 kg per shelf	100%	880 mm	1325 mm	1560 mm	5 shelves, shelf lock
22 126-1	150 kg per shelf	100%	880 mm	1325 mm	1560 mm	6 shelves, shelf lock
22 127-1	150 kg per shelf	100%	880 mm	1325 mm	1560 mm	7 shelves, shelf lock
22 128-1	150 kg per shelf	100%	880 mm	1325 mm	1560 mm	8 shelves, shelf lock
22 129-1H	150 kg per shelf	100%	880 mm	1325 mm	1710 mm	9 shelves, shelf lock



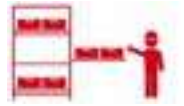

**Compact Storage Unit**  
**Short-side handled**  
**70% 2-way pull-out**

ART. NO.						SPECIFICATION
	200 kg per shelf	70% 2-way	WIDTH	DEPTH	HEIGHT	
22 131-0	200 kg per shelf	70% 2-way	880 mm	1314 mm	1560 mm	1 shelf
22 132-0	200 kg per shelf	70% 2-way	880 mm	1314 mm	1560 mm	2 shelves
22 133-0	200 kg per shelf	70% 2-way	880 mm	1314 mm	1560 mm	3 shelves
22 134-0	200 kg per shelf	70% 2-way	880 mm	1314 mm	1560 mm	4 shelves
22 135-0	200 kg per shelf	70% 2-way	880 mm	1314 mm	1560 mm	5 shelves
22 136-0	200 kg per shelf	70% 2-way	880 mm	1314 mm	1560 mm	6 shelves
22 137-0	200 kg per shelf	70% 2-way	880 mm	1314 mm	1560 mm	7 shelves
22 138-0	200 kg per shelf	70% 2-way	880 mm	1314 mm	1560 mm	8 shelves
22 139-0	200 kg per shelf	70% 2-way	880 mm	1314 mm	1560 mm	9 shelves



Pick storage bins, see page 118-119

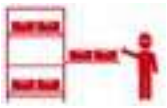



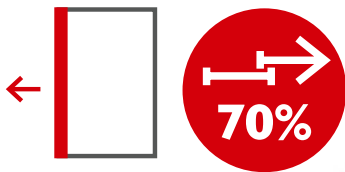

Worktop, handle, and more accessories, see pages 72 - 75



*Bestsellers!*

**Compact Storage Unit  
Long-side handled  
70%**

ART. NO.	 200 kg per shelf	 70% 1-way	 WIDTH	 DEPTH	 HEIGHT	SPECIFICATION
22 211-0	200 kg per shelf	70% 1-way	1280 mm	900 mm	1560 mm	1 shelf
22 212-0	200 kg per shelf	70% 1-way	1280 mm	900 mm	1560 mm	2 shelves
22 213-0	200 kg per shelf	70% 1-way	1280 mm	900 mm	1560 mm	3 shelves
22 214-0	200 kg per shelf	70% 1-way	1280 mm	900 mm	1560 mm	4 shelves
22 215-0	200 kg per shelf	70% 1-way	1280 mm	900 mm	1560 mm	5 shelves
22 216-0	200 kg per shelf	70% 1-way	1280 mm	900 mm	1560 mm	6 shelves
22 217-0	200 kg per shelf	70% 1-way	1280 mm	900 mm	1560 mm	7 shelves
22 218-0	200 kg per shelf	70% 1-way	1280 mm	900 mm	1560 mm	8 shelves
22 219-0	200 kg per shelf	70% 1-way	1280 mm	900 mm	1560 mm	9 shelves
22 212-1	200 kg per shelf	70% 1-way	1280 mm	900 mm	1560 mm	2 shelves, shelf lock
22 213-1	200 kg per shelf	70% 1-way	1280 mm	900 mm	1560 mm	3 shelves, shelf lock
22 214-1	200 kg per shelf	70% 1-way	1280 mm	900 mm	1560 mm	4 shelves, shelf lock
22 215-1	200 kg per shelf	70% 1-way	1280 mm	900 mm	1560 mm	5 shelves, shelf lock
22 216-1	200 kg per shelf	70% 1-way	1280 mm	900 mm	1560 mm	6 shelves, shelf lock
22 217-1	200 kg per shelf	70% 1-way	1280 mm	952 mm	1560 mm	7 shelves, shelf lock
22 218-1	200 kg per shelf	70% 1-way	1280 mm	952 mm	1560 mm	8 shelves, shelf lock
22 219-1H	200 kg per shelf	70% 1-way	1280 mm	952 mm	1710 mm	9 shelves, shelf lock

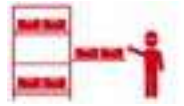

Feel free to contact us if you need assistance!  
**INFO@SMARTSTORING.SE**  
**+46 304 80 90 80**

Picking and storage bins, see page 118.

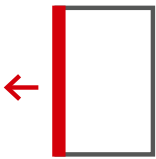

**Compact Storage Unit**  
**Long-side handled**  
**100%**



ART. NO.	KG	100%	WIDTH	DEPTH	HEIGHT	SPECIFICATION
22 221-0	150 kg per shelf	100% 1-way	1280 mm	900 mm	1560 mm	1 shelf
22 222-0	150 kg per shelf	100% 1-way	1280 mm	900 mm	1560 mm	2 shelves
22 223-0	150 kg per shelf	100% 1-way	1280 mm	900 mm	1560 mm	3 shelves
22 224-0	150 kg per shelf	100% 1-way	1280 mm	900 mm	1560 mm	4 shelves
22 225-0	150 kg per shelf	100% 1-way	1280 mm	900 mm	1560 mm	5 shelves
22 226-0	150 kg per shelf	100% 1-way	1280 mm	900 mm	1560 mm	6 shelves
22 227-0	150 kg per shelf	100% 1-way	1280 mm	900 mm	1560 mm	7 shelves
22 228-0	150 kg per shelf	100% 1-way	1280 mm	900 mm	1560 mm	8 shelves
22 229-0	150 kg per shelf	100% 1-way	1280 mm	900 mm	1560 mm	9 shelves
22 222-1	150 kg per shelf	100% 1-way	1280 mm	952 mm	1560 mm	2 shelves, shelf lock
22 223-1	150 kg per shelf	100% 1-way	1280 mm	952 mm	1560 mm	3 shelves, shelf lock
22 224-1	150 kg per shelf	100% 1-way	1280 mm	952 mm	1560 mm	4 shelves, shelf lock
22 225-1	150 kg per shelf	100% 1-way	1280 mm	952 mm	1560 mm	5 shelves, shelf lock
22 226-1	150 kg per shelf	100% 1-way	1280 mm	952 mm	1560 mm	6 shelves, shelf lock
22 227-1	200 kg per shelf	100% 1-way	1280 mm	952 mm	1560 mm	7 shelves, shelf lock
22 228-1	200 kg per shelf	100% 1-way	1280 mm	952 mm	1560 mm	8 shelves, shelf lock
22 229-1H	200 kg per shelf	100% 1-way	1280 mm	952 mm	1710 mm	9 shelves, shelf lock

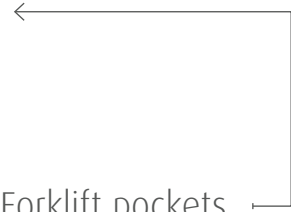

Forklift pockets, wheel kits and more accessories, see page 72 - 75

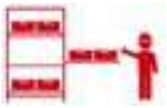

**NEW!**



**LOAD CAPACITY  
300 KG PER SHELF**



### Compact Storage Unit – 300 kg per shelf

The Compact Storage Module offers compact storage for a large number of details. It is excellent for smaller items with a higher load that need to be handled manually. All shelves lock automatically in the retracted position. This variant is available with 3, 4, or 5 shelves and with or without a shelf lock.



ART. NO.	LOAD CAPACITY	LOAD CAPACITY	WIDTH	DEPTH	HEIGHT	SPECIFICATION
22 1233-0	300 kg per shelf	100% 1-way	880 mm	1289 mm	1560 mm	3 shelves
22 1234-0	300 kg per shelf	100% 1-way	880 mm	1289 mm	1560 mm	4 shelves
22 1235-0	300 kg per shelf	100% 1-way	880 mm	1289 mm	1560 mm	5 shelves
22 1233-1	300 kg per shelf	100% 1-way	880 mm	1322 mm	1560 mm	3 shelves, shelf lock
22 1234-1	300 kg per shelf	100% 1-way	880 mm	1322 mm	1560 mm	4 shelves, shelf lock
22 1235-1	300 kg per shelf	100% 1-way	880 mm	1322 mm	1560 mm	5 shelves, shelf lock

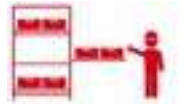

## ELECTRIC TUGGER – MAKES IT EASY TO MOVE!

Easy-to-use and nimble tugger, meticulously designed to effortlessly and securely transport heavy loads on wheels. An ideal aid that streamlines work processes and contributes to preventing health issues and accidents. The electric gripper locks the unit securely with just the push of a button, ensuring safe and stable load transport.



**TOWING CAPACITY  
1200 KG**



The mounting bracket for the electric tugger is included with the selected Compact Storage Module

### Electric tugger for Compact Storage Unit

Designed for easy movement of Compact Storage Units – easy to maneuver and use. Handles loads of up to 1.2 tons with minimal effort. It has an automatic braking system that ensures controlled stops if the operator releases the handle. An additional safety feature is the electric gripper that securely locks the Compact Storage Module in place, ensuring that the load is safely and stably transported. With foam-filled puncture-proof wheels on a differential axle, the electric tugger moves smoothly and steadily, providing a secure operation.

ART. NO.	TOWING CAPACITY	HASTIGHET	WIDTH	LENGTH	HEIGHT	SPECIFICATION
22 DR12	1200 kg	max 5 km/h	495 mm	854 mm	1015/1060 mm	Drive wheel: 260 mm Power: 400 W

Combine the electric tugger with any Compact Storage Module of your choice. Feel free to contact us if you need assistance!

**INFO@SMARTSTORING.SE**  
**+46 304 80 90 80**

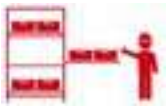

# Smaller CSU Light & smarter!

Introducing the CSU (Compact Storage Unit) Light: Smaller, smarter, and loaded with options! Our CSU Light boasts a more compact size compared to its larger counterparts, making it ideal for space-constrained environments. Its reduced dimensions enable seamless integration into tight spaces, optimizing storage capacity without occupying excessive room. Furthermore, our component bins fit perfectly, enhancing storage efficiency even further.

We help you find the right solutions!

INFO@SMARTSTORING.SE  
+46 304 80 90 80

**NEW!**



## CSU Light Short-side handled

A CSU with shelves that have a loading capacity of 75 kg and an area of 800 x 800 mm. The module's dimensions are well-suited for placement on the floor within a pallet rack or as a standalone unit. The spacious shelf dimensions allow convenient storage of items in component bins, and with 100% pull-out capacity, they are all easily accessible. Choose between two shelf configurations: one with a height of 110 mm per shelf and a total of 11 shelves per unit, and the other with a height of 180 mm per shelf and 7 shelves per unit. Make the CSU Light a stylish cabinet by adding steel cladding. Make it mobile by adding wheel kit 22 1200-N or 22 1200-P, more info on page 72.

↑  
Width 900 mm  
Depth 838 mm

ART. NO.	KG					SPECIFICATION
22 7511-1	75 kg / shelf	100%	900 mm	838 mm	1560 mm	11 shelves. Height per shelf 110 mm
22 7507-1	75 kg / shelf	100%	900 mm	838 mm	1560 mm	7 shelves. Height per shelf 180 mm



### Steel cladding

ART. NO.	SPECIFICATION
22 100-1L-75	Short-side handled CSU Light
22 100-20L-75	Long-side handled CSU Light

More info, see page 75

Transform your  
CSU Light  
**INTO A CABINET**



**LOAD CAPACITY**  
**75 KG PER SHELF**

**NO INSTALLATION**  
**OR ASSEMBLY**  
**REQUIRED**

**7 OR 11 PULL-OUT**  
**SHELVES** per unit



**NEW!**

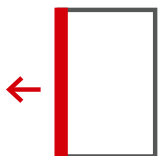

### CSU Light Long-side handled

A CSU with shelves that have a loading capacity of 75 kg and an area of 1200 x 800 mm. The module's dimensions are well-suited for placement on the floor within a pallet rack or as a standalone unit. The spacious shelf dimensions allow convenient storage of items in component bins, and with 100% pull-out capacity, they are all easily accessible. Choose between two shelf configurations: one with a height of 110 mm per shelf and a total of 11 shelves per unit, and the other with a height of 180 mm per shelf and 7 shelves per unit. Make the CSU Light a stylish cabinet by adding steel cladding. Make it mobile by adding wheel kit 22 1200-N or 22 1200-P; more info on page 72.

Can be equipped  
with steel  
cladding and  
wheels, see  
page 72 - 75

ART. NO.	KG	100%	WIDTH	DEPTH	HEIGHT	SPECIFICATION
22 7511-2	75 kg / shelf	100%	1300 mm	838 mm	1560 mm	11 shelves. Height per shelf 110 mm
22 7507-2	75 kg / shelf	100%	1300 mm	838 mm	1560 mm	7 shelves. Height per shelf 180 mm

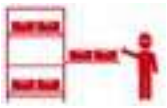

### ! AVOID TIPPING RISK

If you want wheels or forklift pockets, in some cases, counterweights may be needed to avoid tipping. Contact us for more information.

## Transport lock

Locks all shelves and prevents them from unintentionally sliding out during transport. Especially important during truck transports. When in use, you can easily place the locking bar in the open position by locking it with a built-in spring-loaded locking pin. When moving, simply pull the locking knob, and the locking bar will automatically fall into the locked position. When retrofitting, holes must be drilled in the CSU frame.

ART. NO.	SPECIFICATION
22 301-0	Fits Compact Storage Module with Height 1560 mm
22 301-1	Fits Compact Storage Module with Height 1704 mm

## Floor mounting brackets

An accessory that makes it easier to bolt the Compact Storage Module to the floor when it's difficult to access the existing holes in the frame. For example, when you have several units standing side by side.

ART. NO.	SPECIFICATION
22 302-0	2 pcs brackets and bolts for concrete floor



## Wheel kits

With wheels, you can make your Compact Storage Module mobile and independent. The wheel kits come complete with frame brackets and mounting hardware, and they can be retrofitted. The wheel diameter is 150 mm. The wheels have to be mounted by the customer, and typically, the two swivel wheels with brakes are mounted on the front side. If you wish to move the unit independently in all directions, please contact us, and we will provide a wheel kit with 4 swivel wheels.

**Choose the appropriate wheel kit** by multiplying the load capacity of each shelf by the number of shelves and adding the empty weight of the CSU. Select a kit with equal or greater load capacity.

ART. NO.	MAX LOAD UNIT	SPECIFICATION
22 0450-N	450 kg	Wheel kit IB, 4 nylon wheels: 2 swivel wheels and 2 swivel wheels with brakes
22 1200-N	1200 kg	Wheel kit IB, 4 nylon wheels: 2 fixed wheels and 2 swivel wheels with brakes
22 1200-P	1200 kg	Wheel kit IB, 4 polyurethane wheels: 2 fixed wheels and 2 swivel wheels with brakes
22 1800-P	1800 kg	Wheel kit IB, 4 polyurethane wheels: 2 fixed wheels and 2 swivel wheels with brakes

**Swivel wheels:** Rotate 360 degrees around their vertical axis, enabling easy changes of direction.

**Fixed wheels:** Wheels mounted on brackets and roll parallel to the unit's sides.

**Nylon wheels:** Hard material – rolls with less resistance, more durable but a bit noisy.

**Polyurethane wheels:** Softer material – silent but with a bit higher rolling resistance.





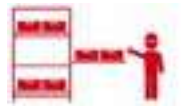

Feel free to contact us if you need assistance!  
**INFO@SMARTSTORING.SE**  
**+46 304 80 90 80**

For effortless transport of CSUs, learn more about our Electric tugger on page 69

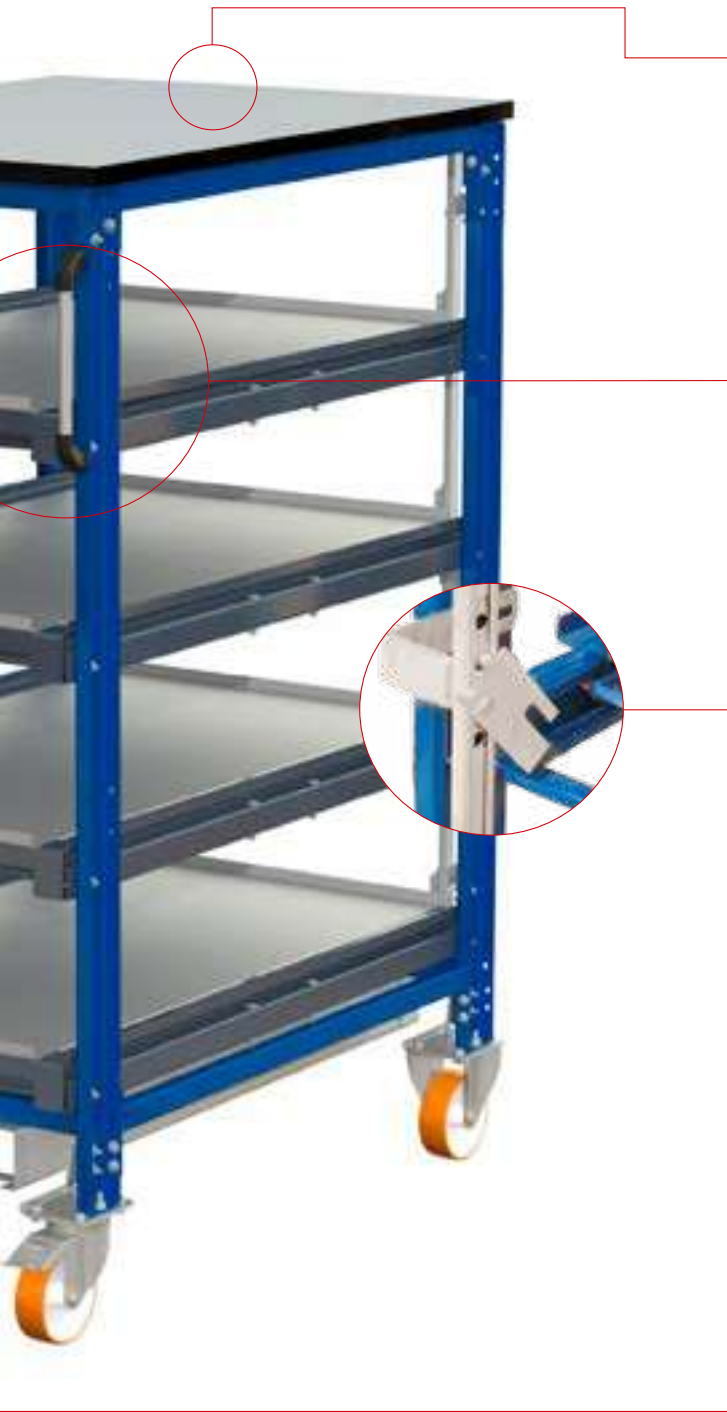

### Worktop

Grey linoleum, with 4 x M8 bolts. 30 mm thick worktop with mounted insert nuts. The worktop consists of a solid wood core with chipboard. Surface covering of grey linoleum with a black edge. For different materials or colours, please request a quote.

ART. NO.	DEPTH x WIDTH x HEIGHT	SPECIFICATION
22 000-1	1210 x 905 x 30 mm	Worktop for short-side handled frame
22 000-9	1285 x 805 x 30 mm	Worktop for long-side handled frame

### Side handle

Practical, sturdy handle for pulling the unit when handling them on wheels. Aluminum tube with a thermoplastic side piece. Delivered fully assembled. When retrofitting, one hole must be drilled in the CSU frame.



ART. NO.	SPECIFICATION
22 503-0-300	Length 300 mm. Diameter Ø30 mm

### Connection kit

Used to screw together Compact Storage Units side by side. Connecting the cabinets increases the total weight of the unit, which can be advantageous to prevent tipping.



ART. NO.	SPECIFICATION
22 303-0	4 pcs connecting nuts and 8 pcs screws

### Shelf lock

If you need to move your cabinet or use it in a way where it's not bolted to the floor, we recommend a shelf lock. This prevents more than one shelf from being extended at the same time and ensures that the unit cannot tip over. *Please contact us to place an order.*



Select a CSU with shelf lock if it's not going to be bolted to the floor

### Forklift pockets

You can transport your Compact Storage Module using a forklift. It's a safe way to make your unit mobile. For this, you'll need forklift pockets, which are steel channels for forklift forks. These are mounted on the bottom of the base frame. Choose between short or long-side handling. On request, you can also get a four-way handling solution. Delivered assembled.



ART. NO.	SPECIFICATION
22 300-1	Forklift pockets for short-side handled CSU. Length 1190 mm
22 300-2	Forklift pockets for long-side handled CSU. Length 790 mm

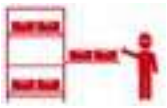

Plastic shelf frame

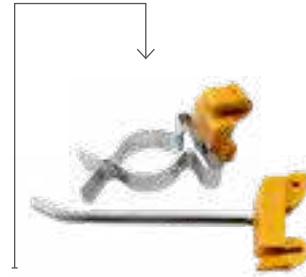

### TOOL BOARD WITH HOOKS

Make the CSU even smarter by incorporating a tool board on one or both sides. We offer a selection of hooks for different tools - get in touch with us for more details!



Shelf frame of wood



Shelf frame of steel



## Shelf frames and dividers

A common and cost-effective method for securing items on shelves is to install a wooden frame around the edges. Utilizing slotted plywood dividers, you can effortlessly create 4, 8, or 16 smaller compartments within the frame. Shelf frames are also available in steel and plastics, and our plastic dividers on page 115 can be used to create smaller compartments within them. All shelf frames and dividers are crafted from recyclable materials.

### ART. NO. SPECIFICATION

5903004-P	Complete kit with 22 500-0 frame of wood and dividers for 4 compartments, 570 x 372 mm
5903008-P	Complete kit with 22 500-0 frame of wood and dividers for 8 compartments, 372 x 280 mm
5903016-P	Complete kit with 22 500-0 frame of wood and dividers for 16 compartments, 280 x 180 mm
22 500-0	Shelf frame of wood, height 195 mm
22 505-0	Plastic shelf frame 1200 x 800 x 200 mm
16 80114	Shelf frame of steel 1200 x 800 x 100 mm

## Shelf fronts

Shelf fronts featuring a surrounding frame provide a sleek and stylish flat face for the CSU. These can be combined with steel cladding for a fully enclosed module. Please note that they are not suitable for retrofitting and must be ordered together with a CSU. Delivered fully assembled. **Not for retrofit.**

### ART. NO. SPECIFICATION

22 102	Quoted upon request
--------	---------------------

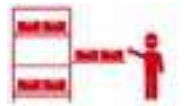

## Custom colour choice

Our standard colours are graphite grey RAL 7024 and blue RAL 5010. Personalize your order by selecting colours that match your preferences. We are happy to supply products in any combination of RAL colours for an extra cost and a slightly extended lead time.

ART. NO.	SPECIFICATION
RALSTART	Quoted upon request



Choose your own colour!  
**ONE OF OUR MOST POPULAR OPTIONS!**

## Double doors

Doors can swing open 180°, providing convenient access to the shelves. Doors are secured with a multi-point lock located on the right door. These can be combined with steel cladding for a fully enclosed module. Please note that they are not suitable for retrofitting and must be ordered together with a CSU. Delivery is made fully assembled.

ART. NO.	SPECIFICATION
22 101-0	Includes door frame and latch lock



WE ALSO HAVE WEATHER PROTECTION IN PLASTIC

Contact us for more information!



## Steel cladding for CSU Light

Transform your CSU Light into a stylish, fully enclosed cabinet. Choose between standard or custom paint colours or a galvanized finish. Constructed with sheet metal. Please note that it's not suitable for retrofitting and must be ordered together with a CSU Light. Delivered fully assembled.

ART. NO.	SPECIFICATION
22 100-1L-75	Short-side handled
22 100-20L-75	Long-side handled

## Steel cladding

Enhance your Compact Storage Unit's security with steel cladding, completely enclosing it and converting it into a secure cabinet when paired with shelf fronts or doors. Perfect for dusty environments or for keeping items securely locked away. Tailor your purchase by choosing to include or exclude shelf fronts and doors. Select from standard or custom paint colours, or opt for a galvanized finish to suit your space. Delivered fully assembled for your convenience, it's an integral addition to your storage solution. Please note: The enclosure kits provided below are specifically designed for short-side handled units. Contact us for details on sheet metal enclosures tailored for long-side handled units.

ART. NO.	SPECIFICATION
22 100-0	For CSU 70% with back panel, sides, and top
22 100-1	For CSU 100% with back panel, sides, and top
22 100-2	For CSU 70% with back panel and sides. A good choice if you prefer a worktop on top instead of a sheet metal top
22 100-3	For CSU 100% with back panel and sides. A good choice if you prefer a worktop on top instead of a sheet metal top
22 100-4	For CSU 70% 2-way with sides and top
22 100-5	For CSU 70% 2-way with sides and <i>no</i> top. A good choice if you prefer a worktop on top instead of a sheet metal top

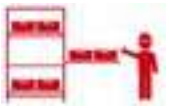

# Mobile Pallet Units (MPU)

Mobile Pallet Units are similar to Compact Storage Units but designed for handling heavier loads such as pallets and boxes. This means they can be loaded with a forklift and are robust enough for tough handling. They are also designed to be mobile – either with a forklift or by rolling on their own wheels. These units are often used in assembly areas in factories.

If you manufacture large products like generators and turbines, it's essential to ensure that your workstations have materials readily

The configuration can be customized!

Get in touch with us to find the right solution.

[INFO@SMARTSTORING.SE](mailto:INFO@SMARTSTORING.SE)  
+46 304 80 90 80

available. Mobile material carts with pull-out units store materials exactly where you need them and in a space-saving manner.

## FLEXIBLE STORAGE

Customize to your needs!

Short-side, long-side or four-sided forklift pockets for

## EASY HANDLING

MOVE WITH A FORKLIFT OR ON ITS WHEELS



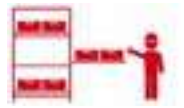

# For heavy-duty use!



The frame is a sturdy steel structure with posts that have a hole spacing of 30 mm center-to-center for shelf installation.



**100%  
PULL-OUT CAPACITY**



**70%  
PULL-OUT CAPACITY**



**LOAD CAPACITY  
300 KG PER SHELF**

## **NO INSTALLATION REQUIRED!**

The units are delivered fully assembled and function-tested

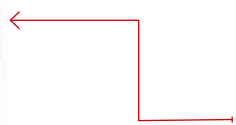

**SHELF LOCK** ensures that only one shelf at a time can be extracted

Counterweights, in combination with shelf lock, make the unit secure against tipping



**OPTIONAL WHEEL KITS**, select type according to your needs

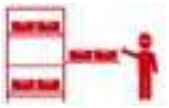



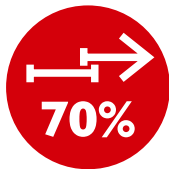

Optional steel top shelf for additional storage

We can customise it to suit your needs!



Optional FIFO flow shelf; please contact us for information

**MPU – Mobile Pallet Unit**  
**70% pull-out capacity**  
**Short-side handled for EUR pallets**

ART. NO.	 KG					SPECIFICATION
21 312-1	300 kg	70%	1016	1403	1760 mm	2 shelves
21 313-1	300 kg	70%	1016	1403	1760 mm	3 shelves

We help you find the right solutions!

**INFO@SMARTSTORING.SE**  
**+46 304 80 90 80**

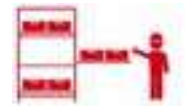

### Wheel kits

ART. NO.	LOAD CAPACITY	SPECIFICATION
22 1200-N	1200 kg	4 nylon wheels: 2 fixed wheels and 2 swivel wheels with brakes
22 1200-P	1200 kg	4 polyurethane wheels: 2 fixed wheels and 2 swivel wheels with brakes
22 1800-P	1800 kg	4 polyurethane wheels: 2 fixed wheels and 2 swivel wheels with brakes

**Nylon Wheels:**  
Hard material - rolls with less resistance, more durable but a bit noisy.

**Polyurethane Wheels:**  
Softer material - silent but with a bit higher rolling resistance

With a wheel kit you can move the MPU by hand!



**MPU – Mobile Pallet Unit**  
**100% pull-out capacity**  
**Short-side handled for EUR pallets**

ART. NO.	KG	100%	WIDTH	DEPTH	HEIGHT	SPECIFICATION
21 322-1	300 kg	100%	1029 mm	1482 mm	1760 mm	2 shelves
21 323-1	300 kg	100%	1029 mm	1454 mm	1760 mm	3 shelves

Choose between 70% or 100% pull-out capacity

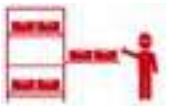

# Tool Storage Units (TSU)

If you operate production processes involving the use of heavy tools, dies and moulds, you have a storage problem. These are not easy items to handle, and yet their ready availability is crucial to everyday operations.

The TSU (Tool Storage Unit) is an efficient and safe solution for handling tools and heavy machine parts. Often combined with an overhead crane so tools safely can be moved to a trolley or directly to the production machinery. Stop moving expensive and easy-to-damage tools around on pallets with a fork lift!

The TSU is delivered fully assembled. All shelves are equipped with a steel shelf panel to accept high point loads and a rubber mat to keep the tools in place.

Feel free to contact us if you need assistance!

[INFO@SMARTSTORING.SE](mailto:INFO@SMARTSTORING.SE)  
+46 304 80 90 80

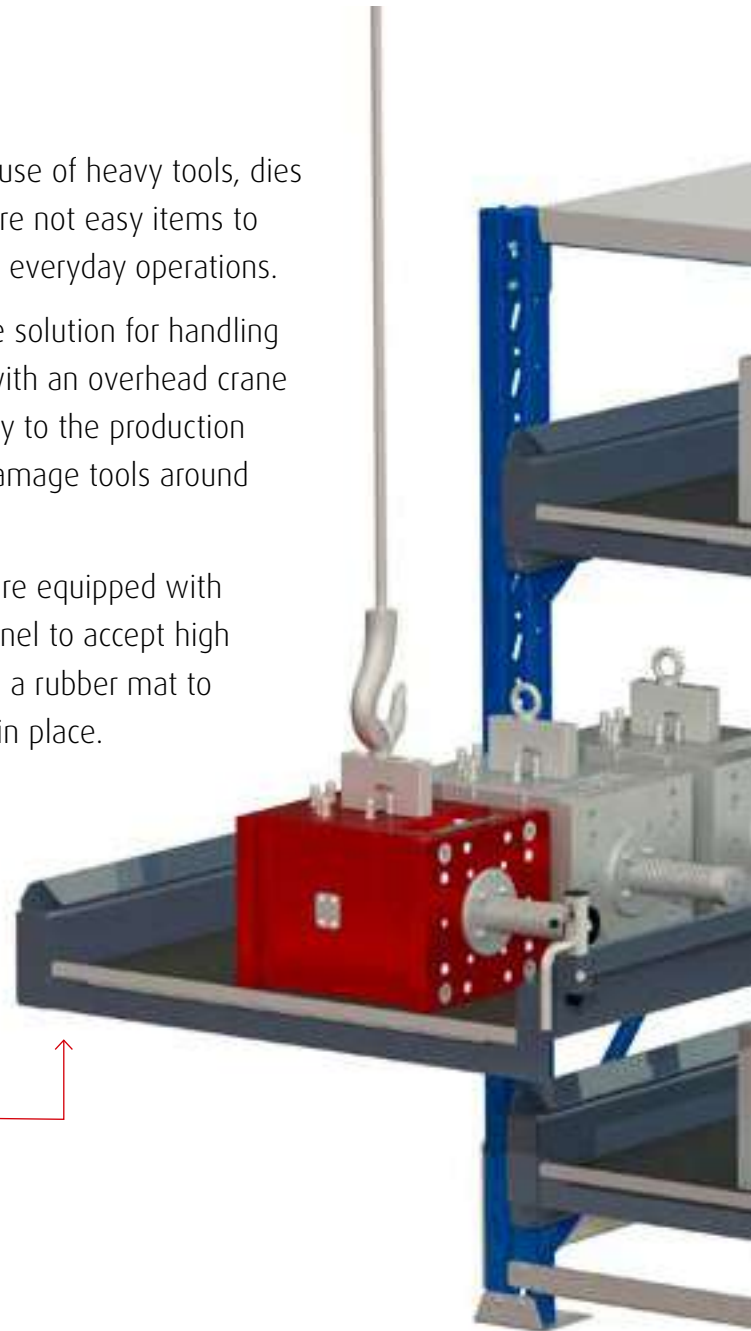

**100%**  
**PULL-OUT CAPACITY**



**70%**  
**PULL-OUT CAPACITY**



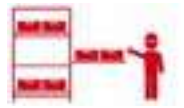

*For heavy tools!*

**NEW!**



**LOAD CAPACITY  
UP TO 3000 KG PER MODULE**

Delivered **FULLY ASSEMBLED**

**STRONG STEEL SHELF PANELS  
FOR HIGH POINT LOADS**

**LOCKS AUTOMATICALLY**  
when pushed in

Lock in extended position  
available as an option



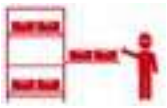

**HIGH-QUALITY BALL  
BEARINGS**



Side panels available on request

### Tool Storage Units (TSU) 70% Pull-out capacity

Front-loaded, short-side handled. For manual handling or overhead crane. Steel panel and rubber mat for each shelf. Standard colours: blue frame and grey shelves. Optional shelf lock which prevents more than one shelf being pulled out at once.

ART. NO.	 600 kg per shelf	 70%	 LOAD WIDTH	 LOAD DEPTH	 HEIGHT	SPECIFICATION
19 112-0	600 kg per shelf	70%	827 mm	1226 mm	1707 mm	2 shelves
19 112-1	600 kg per shelf	70%	827 mm	1226 mm	1707 mm	2 shelves, shelf lock
19 113-0	600 kg per shelf	70%	827 mm	1226 mm	1707 mm	3 shelves
19 113-1	600 kg per shelf	70%	827 mm	1226 mm	1707 mm	3 shelves, shelf lock
19 114-0	600 kg per shelf	70%	827 mm	1226 mm	1707 mm	4 shelves
19 114-1	600 kg per shelf	70%	827 mm	1226 mm	1707 mm	4 shelves, shelf lock
19 115-0	600 kg per shelf	70%	827 mm	1226 mm	1707 mm	5 shelves
19 115-1	600 kg per shelf	70%	827 mm	1226 mm	1707 mm	5 shelves, shelf lock



We help you find the right solutions!  
**INFO@SMARTSTORING.SE**  
**+46 304 80 90 80**

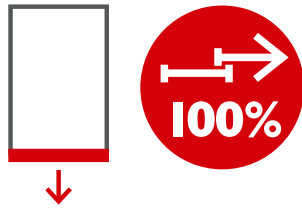

*Bestseller!*

**Tool Storage Units (TSU)**  
**100% Pull-out capacity**

Front-loaded, short-side handled. For manual handling or overhead crane. Steel panel and rubber mat for each shelf. Standard colours: blue frame and grey shelves. Optional shelf lock which prevents more than one shelf being pulled out at once.

Metal shelf on top that can serve as additional storage and dust protection

ART. NO.	KG					SPECIFICATION
			LOAD WIDTH	LOAD DEPTH	HEIGHT	
19 122-0	600 kg per shelf	100%	827 mm	1226 mm	1707 mm	2 shelves
19 122-1	600 kg per shelf	100%	827 mm	1226 mm	1707 mm	2 shelves, shelf lock
19 123-0	600 kg per shelf	100%	827 mm	1226 mm	1707 mm	3 shelves
19 123-1	600 kg per shelf	100%	827 mm	1226 mm	1707 mm	3 shelves, shelf lock
19 124-0	600 kg per shelf	100%	827 mm	1226 mm	1707 mm	4 shelves
19 124-1	600 kg per shelf	100%	827 mm	1226 mm	1707 mm	4 shelves, shelf lock
19 125-0	600 kg per shelf	100%	827 mm	1226 mm	1707 mm	5 shelves
19 125-1	600 kg per shelf	100%	827 mm	1226 mm	1707 mm	5 shelves, shelf lock

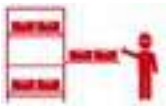

# Pallet Storage Units (PSU)

The PSU (Pallet Storage Unit) is a complete rack system for palletized goods.

If your production processes involve heavy pallets from which you pick components, this storage system is for you. This type of handling can be challenging to achieve within a confined space but can still be crucial for your daily operations.

Here, there is an opportunity for flexible storage where you need it, such as near a machine or production line.

We help you find the right solutions!

[INFO@SMARTSTORING.SE](mailto:INFO@SMARTSTORING.SE)  
+46 304 80 90 80



## FLEXIBLE STORAGE

Provides the flexibility to store materials where you need them, such as near a machine or production line.

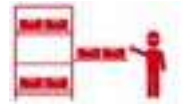

*For heavy-duty pallets  
with pick items!*



**NEW!**



**100%  
PULL-OUT CAPACITY**



**70%  
PULL-OUT CAPACITY**



**LOAD CAPACITY  
UP TO 1800 KG PER MODULE**



**OPTIONAL SHELF LOCK** which prevents more than one shelf being pulled out at once

**NO INSTALLATION REQUIRED**

The units are delivered fully assembled and function-tested!

**ROBUST AND STURDY**

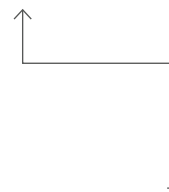
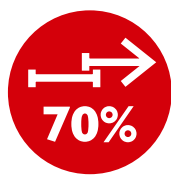
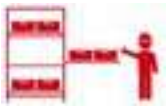

Side panels available on request

### Pallet Storage Units (PSU)

For short-side handled EUR-pallets. Standard colours: blue frame and grey shelves. Optional shelf lock which prevents more than one shelf being pulled out at once. Units without shelf lock can be rear-loaded. Load area: 835 x 1220 mm.



ART. NO.	KG	70%	WIDTH	DEPTH	HEIGHT	SPECIFICATION
15 112-0	600 kg per shelf	70% 1-way	1170 mm	1360 mm	1707 mm	2 shelves
15 113-0	600 kg per shelf	70% 1-way	1170 mm	1360 mm	1707 mm	3 shelves
15 112-1	600 kg per shelf	70% 1-way	1170 mm	1360 mm	1707 mm	2 shelves, shelf lock
15 113-1	600 kg per shelf	70% 1-way	1170 mm	1360 mm	1707 mm	3 shelves, shelf lock



100% Pull-out capacity offers full access to small items far back on a pallet

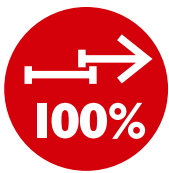

**NEW!**

*Bestseller!*

### Pallet Storage Units (PSU)

For short-side handled EUR-pallets. Standard colours: blue frame and grey shelves. Optional shelf lock which prevents more than one shelf being pulled out at once. Units without shelf lock can be rear-loaded. Load area: 835 x 1220 mm.



ART. NO.	KG	100%	WIDTH	DEPTH	HEIGHT	SPECIFICATION
15 122-0	600 kg per shelf	100% 1-way	1170 mm	1360 mm	1707 mm	2 shelves
15 123-0	600 kg per shelf	100% 1-way	1170 mm	1360 mm	1707 mm	3 shelves
15 122-1	600 kg per shelf	100% 1-way	1170 mm	1360 mm	1707 mm	2 shelves, shelf lock
15 123-1	600 kg per shelf	100% 1-way	1170 mm	1360 mm	1707 mm	3 shelves, shelf lock







# Production lines & areas

To enhance your production efficiency, we offer custom-tailored systems designed to match your workspace requirements precisely. Our modules are engineered to maximize every square meter for production areas, storage, and lean manufacturing.

Discover our range of innovative products, from roller flow shelves to picking faces, and pallet-tilting solutions, meticulously crafted for industrial usage in production areas and warehouses.

Combining storage solutions that effortlessly deliver materials to the picker is key to achieving optimal ergonomics and efficiency.

Alongside our stationary storage solutions, we offer a line of robust carts. What sets these apart is their strength, high load-bearing capacity, and ergonomic design, significantly improving picking sequences.

Modular system that can be configured to fit your needs!

*Efficient!*



# FIFO flow shelves

Maximize efficiency and ease with our versatile materials handling system! Our flow shelves, equipped with rollers, ensure easy access to items. Construct a seamless FIFO system using our shelves in pallet racks for smooth handling of cardboard boxes or plastic bins. Easily pick the oldest stock item first while maintaining a clear view of all components at the picking face. Customize your flow racks with different layouts and roller configurations based on your container sizes.

We help you find the right solutions!

**INFO@SMARTSTORING.SE**  
**+46 304 80 90 80**



Combine pallet-handled products with pull-out drawers and inclined storage to optimize material accessibility. Our Upright-Mounted product offers direct access to various materials in production areas or buffer storage, enhancing convenience and efficiency.

Upright-mounted pull-out units, see page 52-54

*Save space!*



Storage according to  
**THE FIFO PRINCIPLE**

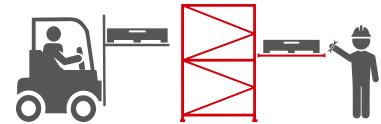
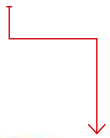

**LOAD ON ONE SIDE  
- PICK & PRODUCE  
ON THE OTHER SIDE**



**FLOW SHELVES  
MAX LOAD CAPACITY  
600 KG PER LEVEL**

→ **FIFO FLOW SHELF**  
with rollers **FOR HIGH  
TURNOVER PRODUCTS**

Save space!

→ **TILTED PALLETS**  
Maximum accessibility  
during picking. Max load  
capacity 500 kg

Easy to install!

Drastic **TIME SAVINGS**  
in order picking

**INCREASED  
PRODUCTIVITY**



More variants of FIFO flow shelves are available at the website.

[WWW.SMARTSTORING.EU](http://WWW.SMARTSTORING.EU)



### End-of-rack FIFO shelves

Increase storage capacity by adding FIFO flow shelves mounted outside the rack. Available in three widths, each containing 2 rollers, 2 side supports and an end stop. It's possible to mount them as return lanes for empty bins or boxes.

ART. NO.	WIDTH	SPECIFICATION
15 902-0202	200 mm	End-of-rack FIFO flow shelf with 2 rollers, side supports and material stop
15 903-0202	300 mm	End-of-rack FIFO flow shelf with 2 rollers, side supports and material stop
15 904-0202	400 mm	End-of-rack FIFO flow shelf with 2 rollers, side supports and material stop

### FIFO flow shelf with adjustable extension

A FIFO flow shelf with a 300 mm extension shelf for easy access. Angle is adjustable for best ergonomics. Select number of lanes to match width of plastic bins or cardboard boxes. Smart steel profiles fit over beams in a pallet rack with a depth of 1100 mm. 1 pcs will fit in a 950 mm wide section.

ART. NO.	WIDTH	DEPTH	SPECIFICATION
15 905-0805	940 mm	1400 mm	8 rollers and 5 dividers, providing 4 channels suitable for plastic bins or cardboard boxes with a maximum width of 200 mm.
15 905-0604	940 mm	1400 mm	6 rollers and 4 dividers, providing 3 channels suitable for plastic bins or cardboard boxes with a maximum width of 300 mm.
15 905-0403	940 mm	1400 mm	4 rollers and 3 dividers, providing 2 channels suitable for plastic bins or cardboard boxes with a maximum width of 400 mm.



DO YOU WANT FIFO FLOW SHELVES IN YOUR STANDARD PALLET RACK?

With our smart solution you can add them where needed and easily move them to another position later.

We help you find the right solutions!

**INFO@SMARTSTORING.SE**  
**+46 304 80 90 80**



### FIFO flow shelves

Select number of lanes to match width of plastic bins or cardboard boxes. Smart steel profiles fit over beams in a pallet rack with a depth of 1100 mm. 1 pcs will fit in a 950 mm wide section.

ART. NO.	WIDTH	DEPTH	SPECIFICATION
15 900-0805	940 mm	1100 mm	FIFO flow shelf with 8 rollers and 5 dividers, providing 4 channels suitable for plastic bins or cardboard boxes with a maximum width of 200 mm.
15 900-0604	940 mm	1100 mm	FIFO flow shelf with 6 rollers and 4 dividers, providing 3 channels suitable for plastic bins or cardboard boxes with a maximum width of 300 mm.
15 900-0403	940 mm	1100 mm	FIFO flow shelf with 4 rollers and 3 dividers, providing 2 channels suitable for plastic bins or cardboard boxes with a maximum width of 400 mm.

### Narrow FIFO flow-shelves

A narrow FIFO flow shelf that can be turned in opposite direction to become a return lane for empty bins or boxes. Smart steel profiles fit over beams in a pallet rack with a depth of 1100 mm. 2 pcs will fit in a 950 mm wide section.

ART. NO.	WIDTH	DEPTH	SPECIFICATION
15 901-0403	470 mm	1100 mm	FIFO flow shelf with 4 rollers and 3 dividers, providing 2 channels suitable for plastic bins or cardboard boxes with a maximum width of 200 mm
15 901-0402	470 mm	1100 mm	FIFO flow shelf with 4 rollers and 2 dividers, providing 1 channel suitable for plastic bins or cardboard boxes with a maximum width of 400 mm



Good overview and  
**CONVENIENT PICKING!**

<sup>1</sup>  
Upright-mounted pull-out  
units, see page 52-54



### Worktop

Turn your pallet rack section into a workbench. Complete section with upright-mounted profiles and a 28 mm worktop. Fit our standard racks only, for other brands please contact us.

ART. NO.	WIDTH	DEPTH	SPECIFICATION
15 911-0	940 mm	1100 mm	Complete set for 950 mm section



### Pallet tilt profiles

Pallet tilt profiles allows full access to components in a pallet. The pallet is loaded by a fork lift or stacker truck, normally from the rear. When the forks are lowered, the pallet slowly tilts forward giving access to the goods. When the pallet is empty, the operator pushes the pallet back and it will sit horizontally, ready to be picked up and replaced with a full pallet. For short-side handled EUR pallets. Fits our standard rack with section width 950 mm.

ART. NO.	WIDTH	DEPTH	SPECIFICATION
15 500-0	892 mm	1100 mm	Max pallet weigh 500 kg



**NEW!**

### Cable drum storage

A practical solution for storing cable drums in pallet racking. Pull cable to unwind drum. Buy 1 set of beams and 1-3 axles depending on how many drums that fits in depth. Fits our standard racks only, for other brands please contact us.

ART. NO.	SPECIFICATION
15 510-1	Axle holder, for 1 to 3 positions in depth. Max total load 500 kg
15 510-4	50 mm axle for section width 950 mm. Max load 500 kg

### Tool board and covering panels for frame uprights

Smooth or perforated panels to be installed directly in the pallet rack construction. A simple accessory that truly enhances your interior. Get a sleek and smooth upright in your pallet racks or tool boards at the production area.

ART. NO.	WIDTH	HEIGHT	SPECIFICATION
62 601050P	1050 mm	500 mm	Upright-mounted tool panel
62 601050R	1050 mm	500 mm	Upright-mounted covering panel
62 201050R	1050 mm	200 mm	Upright-mounted covering panel

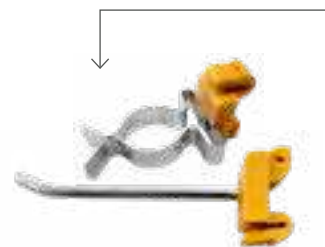

Tool boards and hooks at [smartstoring.eu](http://smartstoring.eu)



This MPU is equipped with an optional FIFO flow shelf, contact us for further information



### MPU – Mobile Pallet Unit 70% pull-out capacity Short-side handled for EUR pallets

ART. NO.						SPECIFICATION
21 312-1	300 kg	70%	1016	1403	1760 mm	2 shelves
21 313-1	300 kg	70%	1016	1403	1760 mm	3 shelves



### Wheel kits

ART. NO.	LOAD CAPACITY	SPECIFICATION
22 1200-N	1200 kg	4 nylon wheels: 2 fixed wheels and 2 swivel wheels with brakes
22 1200-P	1200 kg	4 polyurethane wheels: 2 fixed wheels and 2 swivel wheels with brakes
22 1800-P	1800 kg	4 polyurethane wheels: 2 fixed wheels and 2 swivel wheels with brakes

**Nylon Wheels:** Hard material – rolls with less resistance, more durable but a bit noisy.  
**Polyurethane Wheels:** Softer material – silent but with a bit higher rolling resistance.

Choose the wheel kits you prefer!

### MPU – Mobile Pallet Unit 100% pull-out capacity Short-side handled for EUR pallets

ART. NO.						SPECIFICATION
21 322-1	300 kg	100%	1029 mm	1482 mm	1760 mm	2 shelves
21 323-1	300 kg	100%	1029 mm	1454 mm	1760 mm	3 shelves







Cart for efficient storage and transportation of tyres!

### Tire cart Somis

Store and move tyres in an efficient way! Each shelf consists of 2pcs 1000 or 1800 mm long tubes about 400 mm apart. 4 swivel wheels, 2 of them with brakes. 2 handle grips on one side makes cart easy to move.

ART. NO.	WIDTH	HEIGHT	SPECIFICATION
14 6518-3	1800 mm	1850 mm	3 levels with space for 24 tires max diam 600 mm
14 6510-3	1000 mm	1850 mm	3 levels with space for 12 tires max diam 600 mm



With roller tracks and dividers in the FIFO flow shelf (First In First Out), the material automatically reaches the picker, and the oldest item is picked first.



**NEW!**

2 levels + 1 inclined steel shelf panel



5 levels



3 levels and side-mounted return shelf

### FIFO cart

FIFO Carts are perfect for storage of pick bins in a production area and makes it easy to follow Kanban principles. New bins are replenished on the opposite side as needed. Shelves can be moved in increments of 30 mm and it is easy to add additional levels when needed. The cart has robust high-quality wheels, along with two robust handles on one short side for ease of transportation.

See all the variants of our Mobile carts at [WWW.SMARTSTORING.EU](http://WWW.SMARTSTORING.EU)

ART. NO.	↔ FRAME WIDTH	↗ FRAME DEPTH	SHELF WIDTH	SPECIFICATION
14 210302-11-1	1296 mm	800 mm	1220 mm	Long-side handled. 2 FIFO flow shelves + 1 inclined steel shelf panel. Free space between shelves: 306 mm
14 210302-11	1296 mm	1200 mm	1220 mm	Long-side handled. 5 levels of inclined shelves with roller tracks. Open space between shelves: 189 mm
14 210302-13	896 mm	1200 mm	820 mm	Short-side handled. 3 + 1 levels of inclined flow shelves with roller tracks. Side-mounted return shelf: Gravity flow shelf with 2 roller tracks. Length 1200 mm, depth 1297 mm, width 252 mm
14 21302-14	896 mm	1200 mm	820 mm	Short-side handled. 5 levels of inclined shelves with roller tracks
14 913-0	896 mm	1200 mm	820 mm	Short-side handled. 3 levels of inclined shelves with roller tracks. Open space between shelves: 520 mm



### Pallet cart 800 kg

A durable and robust pallet cart that gives access to pallets underneath a pallet rack. Its sturdy steel construction with four durable fixed 100 mm nylon wheels allows it to handle heavy loads. Available in blue or grey. Delivered unassembled.

ART. NO.	 WEIGHT	LENGTH	WIDTH	LOADING HEIGHT	HANDLE HEIGHT	WHEEL DIAMETER	TREAD	WEIGHT
14 1000-0	800 kg	1208 mm	887 mm	128 mm	500 mm (596 mm above floor)	100 mm	Nylon	17 kg



### Pallet cart 1000 kg

A durable and robust pallet cart that gives access to pallets underneath a pallet rack. With an open frame and 4 low-profile delrin wheels, it's possible to load pallets also with a hand pallet truck or a stacker. Available in blue or grey. Delivered unassembled.

Extremely low height

ART. NO.	 WEIGHT	LENGTH	WIDTH	LOADING HEIGHT	HANDLE HEIGHT	WHEEL DIAMETER	TREAD	WEIGHT
14 1000-0	1000 kg	1217 mm	876 mm	68 mm	700 mm (726 mm above floor)	62 mm	Delrin	25 kg





# Long goods

Do you have problems handling long goods or sheet materials? Then we might have a solution!

Our timber storage solutions ensure your wood products are stored safely and efficiently. Your timber inventory remains organized and easily accessible.

Vertical storage solutions are the perfect choice when space is at a premium. By utilizing the height of your facility, you can store more in less floor space.

Wide pull-out shelves make it possible to add sheet material storage into your existing pallet rack.

**CONVENIENT HANDLING  
OF LARGE MATERIALS!**

*Long or flat!*



# Roll-in timber storage racks

Building supply stores need smart solutions that are robust, practical and space-efficient. The typical application is a drive-in hall where customers can pick items themselves. Our system is based on efficiently storing bundles of timber with the short end facing outward, which significantly increase warehouse capacity compared to cantilever racks. More products can be stored in the same area. With robust steel rollers and a clever safety system you can easily load entire bundles of lumber in just a few minutes. Customers can easily pick what they need without assistance from store staff.

- Maximize use of floor space!
- Easy access to more products!

We customize this product, please contact us!

[INFO@SMARTSTORING.SE](mailto:INFO@SMARTSTORING.SE)  
**+46 304 80 90 80**

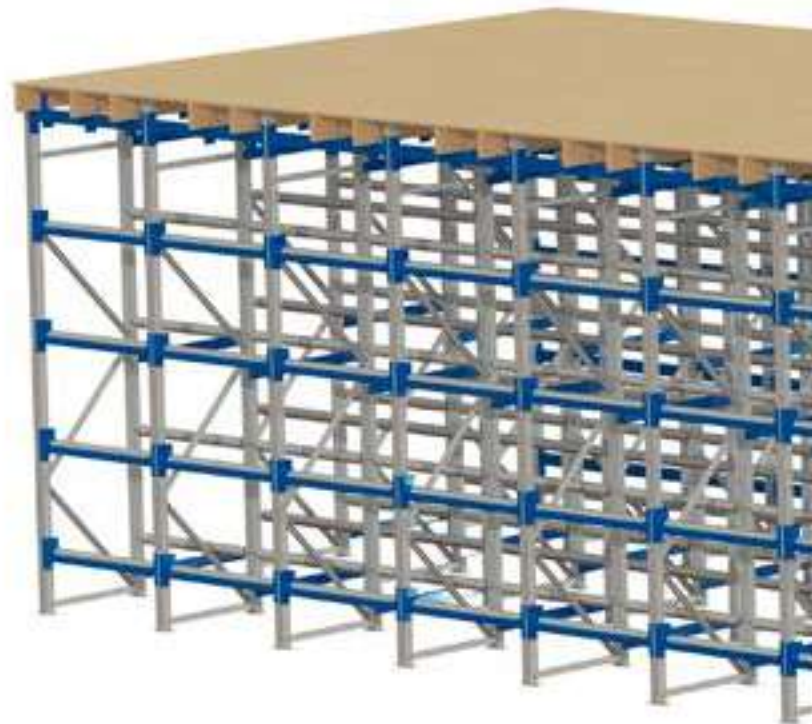

*Perfect for drive-in*



### **FRONT ROLLER STANDARD**

Release lock operated by wing screw when bundles are loaded



### **FRONT ROLLER WITH SAFETY LOCK**

*Lock mode 1:* released in one direction  
– bundles can be loaded without risk for rolling back out

*Lock mode 2:* locked in both directions  
– for picking individual products

*Unlocked mode:* released in both directions  
– bundles can be loaded or unloaded



By adding a mezzanine floor on top, you get more valuable storage area. Contact us for more information!



Build your own timber storage solution with our modular system!

### Roll-in timber storage racks

Build your roll-in timber storage rack with our start and add-on sections. Each section has 3 levels consisting of a front roller and 4 additional plain rollers. On request we can upgrade from standard front roller to the one with safety lock.

ART. NO.	WIDTH	DEPTH	HEIGHT	SPECIFICATION
14 56353-1	1200 mm	5700 mm	3500 mm	Start section
15 56353-2	1200 mm	5700 mm	3500 mm	Add-on section





Feel free to contact us if you need assistance!  
**INFO@SMARTSTORING.SE**  
**+46 304 80 90 80**

Expandable to any width with additional sections.



Add-on section

### Front roller with safety lock

**Lock mode 1** locks the roll in the unwinding direction. It is used when staff loads entire lumber bundles using a forklift or jig but keeps the lumber bundle in place when the customer selects individual items.

**Lock mode 2** completely locks the roll, which is useful when the lumber roll needs to stay securely in place without the bundle moving unintentionally.

**Unlocked mode** is used when entire lumber bundles need to be rearranged in the warehouse.

*We recommend upgrade to front roller with safety lock. Contact us for more information!*



- Lock the roller:
- In one direction
  - In two directions
  - Completely open



*Smart vertical storage!*

## Loop storage racks

We help you find the right solutions!

**INFO@SMARTSTORING.SE**  
**+46 304 80 90 80**

Smart Storing's loop storage racks come with dividers made of bent tube that are hooked into two perforated steel beams, placed behind or above the material. The tubes are only 16 mm in diameter, probably is the thinnest on the market, which allow

for the division of storage into very narrow sections. Dividers can easily be moved by hand in increments of 30 mm. The products receive stable support and are easily accessible.

**WE LOVE SMART STORAGE SOLUTIONS**  
for all type of goods!



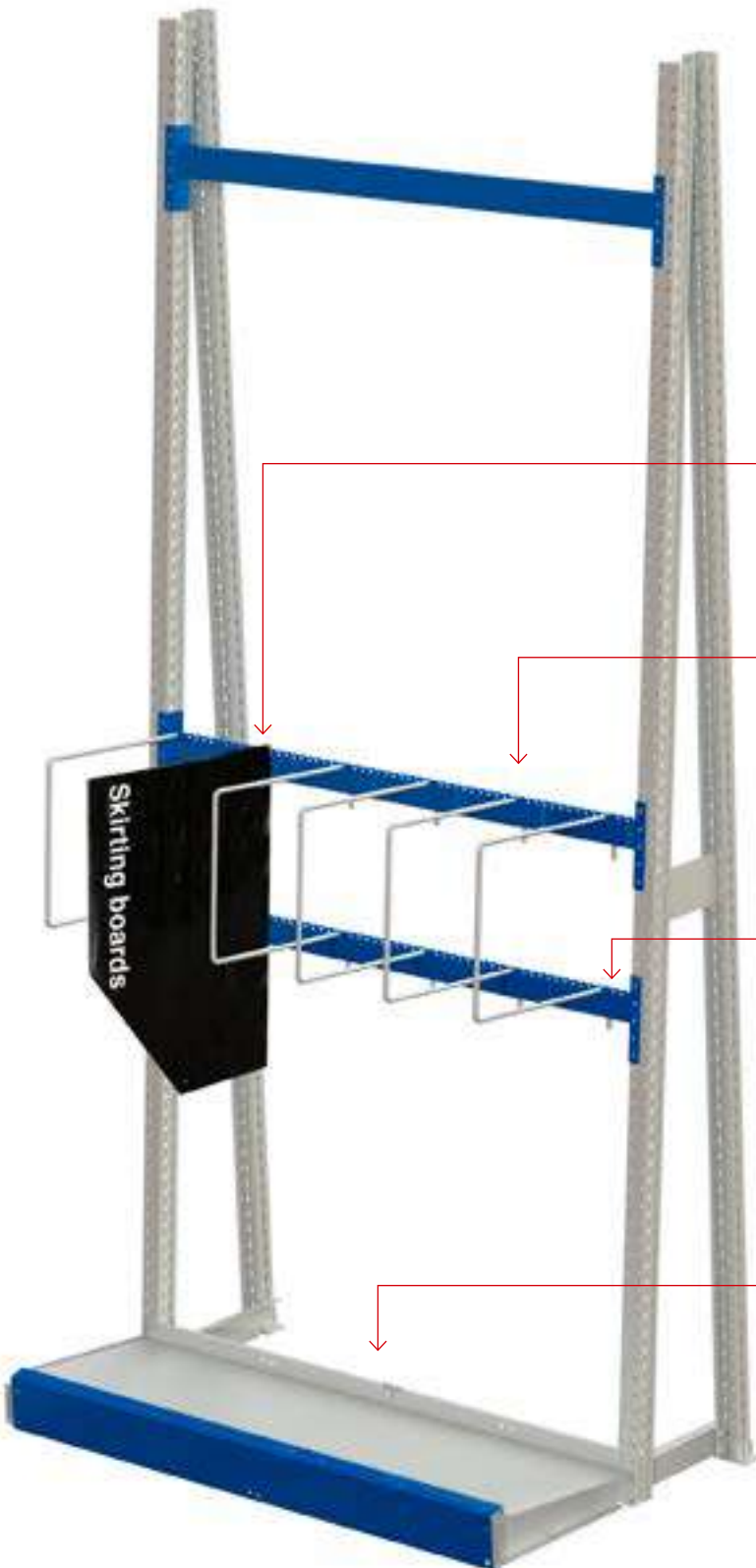

**SMART DESIGN!**

Multi-purpose, suits many long goods

**DIVIDER WITH INTEGRATED SIGN** makes articles easy to find

Adjustable dividers in a slim design keep the material in place

**EASY TO MOVE DIVIDERS,** no tools needed!

Beams are perforated with a dense hole pattern for **OPTIMAL COMPARTEMENT SIZES**

**ROBUST PROFILES** under the cover plates to support heavy loads



### LODUR STANDARD

For industries and shops where price & functionality is most important

- Flat bottom plate placed directly on the floor surface.
- Bottom plate works like a moisture barrier, keeping wood and other sensitive materials dry.
- Beams powder coated blue RAL 5010.



### Lodur Standard, single-sided Start section

ART. NO.	HEIGHT	WIDTH	DEPTH	DIVIDERS
BESG26094-BI	2000 mm	950 mm	600 mm	4 pcs
BESG26186-BI	2000 mm	1800 mm	600 mm	6 pcs
BESG262710-BI	2000 mm	2700 mm	600 mm	10 pcs

ART. NO.	HEIGHT	WIDTH	DEPTH	DIVIDERS
BESG46094-BI	4000 mm	950 mm	600 mm	4 pcs
BESG46186-BI	4000 mm	1800 mm	600 mm	6 pcs
BESG462710-BI	4000 mm	2700 mm	600 mm	10 pcs

### Add-on section

ART. NO.	HEIGHT	WIDTH	DEPTH	DIVIDERS
BESF26094-BI	2000 mm	950 mm	600 mm	4 pcs
BESF26186-BI	2000 mm	1800 mm	600 mm	6 pcs
BESF262710-BI	2000 mm	2700 mm	600 mm	10 pcs

ART. NO.	HEIGHT	WIDTH	DEPTH	DIVIDERS
BESF46094-BI	4000 mm	950 mm	600 mm	4 pcs
BESF46186-BI	4000 mm	1800 mm	600 mm	6 pcs
BESF462710-BI	4000 mm	2700 mm	600 mm	10 pcs



### Lodur Standard, double-sided Start section

ART. NO.	HEIGHT	WIDTH	DEPTH	DIVIDERS
BDSG260908-BI	2000 mm	950 mm	600 mm	8 pcs
BDSG261812-BI	2000 mm	1800 mm	600 mm	12 pcs
BDSG262720-BI	2000 mm	2700 mm	600 mm	20 pcs

ART. NO.	HEIGHT	WIDTH	DEPTH	DIVIDERS
BDSG460908-BI	4000 mm	950 mm	600 mm	8 pcs
BDSG461812-BI	4000 mm	1800 mm	600 mm	12 pcs
BDSG462720-BI	4000 mm	2700 mm	600 mm	20 pcs

### Add-on section

ART. NO.	HEIGHT	WIDTH	DEPTH	DIVIDERS
BDSF260908-BI	2000 mm	950 mm	600 mm	8 pcs
BDSF261812-BI	2000 mm	1800 mm	600 mm	12 pcs
BDSF262720-BI	2000 mm	2700 mm	600 mm	20 pcs

ART. NO.	HEIGHT	WIDTH	DEPTH	DIVIDERS
BDSF460908-BI	4000 mm	950 mm	600 mm	8 pcs
BDSF461812-BI	4000 mm	1800 mm	600 mm	12 pcs
BDSF462720-BI	4000 mm	2700 mm	600 mm	20 pcs



### Dividers

Smart Storing's loop storage racks has vertical dividers that are only 16 mm in diameter, probably is the thinnest on the market, which allow for the division of storage into very narrow sections. This means that you can store more stuff in less space!

ART. NO.	SPECIFICATION
AVD-5-600	Depth 600 mm for Lodur

**ADD EXTRA DIVIDERS** if you want more, smaller, compartments



- Exclusive look with powder coated front kick plates
- Kick plate is ideal for adding price and product labels
- Choose your own look by selecting colour

## LODUR PREMIUM

For industries and shops where appearance matters!



### Lodur Premium, single-sided Start section

ART. NO.	HEIGHT	WIDTH	DEPTH	DIVIDERS
ESG26094-BI	2000 mm	950 mm	600 mm	4 pcs
ESG26186-BI	2000 mm	1800 mm	600 mm	6 pcs
ESG262710-BI	2000 mm	2700 mm	600 mm	10 pcs

ART. NO.	HEIGHT	WIDTH	DEPTH	DIVIDERS
ESG46094-BI	4000 mm	950 mm	600 mm	4 pcs
ESG46186-BI	4000 mm	1800 mm	600 mm	6 pcs
ESG462710-BI	4000 mm	2700 mm	600 mm	10 pcs

### Add-on section

ART. NO.	HEIGHT	WIDTH	DEPTH	DIVIDERS
ESF26094-BI	2000 mm	950 mm	600 mm	4 pcs
ESF26186-BI	2000 mm	1800 mm	600 mm	6 pcs
ESF262710-BI	2000 mm	2700 mm	600 mm	10 pcs

ART. NO.	HEIGHT	WIDTH	DEPTH	DIVIDERS
ESF46094-BI	4000 mm	950 mm	600 mm	4 pcs
ESF46186-BI	4000 mm	1800 mm	600 mm	6 pcs
ESF462710-BI	4000 mm	2700 mm	600 mm	10 pcs



### Lodur premium end plates

Lodur end plates cover the open space between bottom plate and floor and connects to the front kick plate. They provide a neat look and are powder coated in the same colour as the front kick plates. One left and one right plate per each row. Note that double sided racks need two of each type.

#### ART. NO. SPECIFICATION

EP600V1	End plate, left side
EP600H1	End plate, right side



### Lodur Premium, double-sided Start section

ART. NO.	HEIGHT	WIDTH	DEPTH	DIVIDERS
DSG260908-BI	2000 mm	950 mm	600 mm	8 pcs
DSG261812-BI	2000 mm	1800 mm	600 mm	12 pcs
DSG262720-BI	2000 mm	2700 mm	600 mm	20 pcs

ART. NO.	HEIGHT	WIDTH	DEPTH	DIVIDERS
DSG460908-BI	4000 mm	950 mm	600 mm	8 pcs
DSG461812-BI	4000 mm	1800 mm	600 mm	12 pcs
DSG462720-BI	4000 mm	2700 mm	600 mm	20 pcs

### Add-on section

ART. NO.	HEIGHT	WIDTH	DEPTH	DIVIDERS
DSF260908-BI	2000 mm	950 mm	600 mm	8 pcs
DSF261812-BI	2000 mm	1800 mm	600 mm	12 pcs
DSF262720-BI	2000 mm	2700 mm	600 mm	20 pcs

ART. NO.	HEIGHT	WIDTH	DEPTH	DIVIDERS
DSF460908-BI	4000 mm	950 mm	600 mm	8 pcs
DSF461812-BI	4000 mm	1800 mm	600 mm	12 pcs
DSF462720-BI	4000 mm	2700 mm	600 mm	20 pcs

### Select your favourite colour

As standard the perforated beams, front kick plates and end plates are powder coated blue RAL 5010. At a small extra cost, we powder coat them in RAL colour of your choice. Contact us for more information!

#### ART. NO. SPECIFICATION

RALSTART	State RAL-number
----------	------------------



**NEW!**

Top beams for stability

By adding a bottom level with beams with steel panels, you can place the products in a better height and at the same time gain extra storage space underneath

Feel free to contact us if you need assistance!

**INFO@SMARTSTORING.SE**  
**+46 304 80 90 80**

## VERTICAL STORAGE IN STANDARD RACK

We have developed a number of smart solutions for vertically stored goods. Dividers are available in an array of different depths, and beams can be placed behind or over the goods. See the next page for a few of our standard solutions!

Beams are powder-coated blue RAL 5010, and the rest is galvanized. The standard section width is 2700 mm, but upon request, we can provide widths of 1800 mm or 950 mm as well.



### Loke

Standard rack with rear-mounted perforated beams and dividers. Complete solution with bottom beams and steel shelf panels. Section width 2700 mm. Dividers are 500 mm high and 800 mm deep.

ART. NO.	SPECIFICATION
61 25112701	Start section with 20 dividers
61 25112702	Add-on section with 20 dividers



Bottom level with beams with steel shelf panels

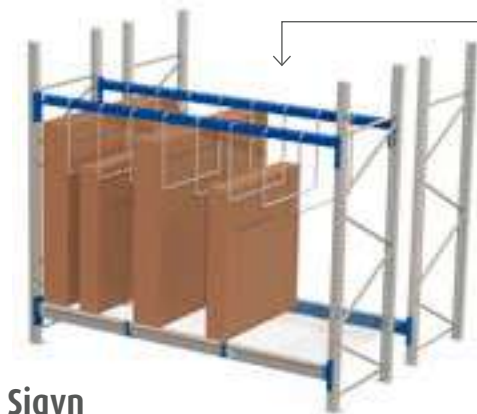

### Sigyn

Standard rack with top-mounted perforated beams and dividers that provides access from both sides of the rack. Complete solution with bottom beams and wire mesh shelf. Section width 2700 mm. Dividers are 800 mm high and 1100 mm deep.

ART. NO.	SPECIFICATION
61 25112705	Start section with 10 dividers
61 25112706	Add-on section with 10 dividers
AVD-8-1100A	Extra divider

Top-mounted dividers provides access from both sides



### Nari

Standard rack with top-mounted perforated beams and dividers that provides access from both sides of the rack. Complete solution with bottom beams and steel shelf panel. Front-mounted rollers ease the process of loading and unloading. Section width 2700 mm. Dividers are 800 mm high and 1100 mm deep.

ART. NO.	SPECIFICATION
61 25112703	Start section with 10 dividers
61 25112704	Add-on section with 10 dividers
AVD-8-1100A	Extra divider

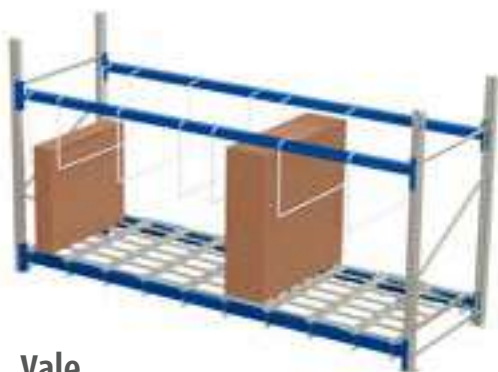

### Vale

Standard rack with top-mounted perforated beams and dividers that provides access from both sides of the rack. Complete solution with a beam-mounted roller bed that makes handling effortless. Section width 2700 mm. Dividers are 800 mm high and 1100 mm deep.

ART. NO.	SPECIFICATION
61 25112707	Start section with 10 pcs dividers
61 25112708	Add-on section with 10 dividers
AVD-8-1100A	Extra divider

Roller bed for easy handling of heavy goods

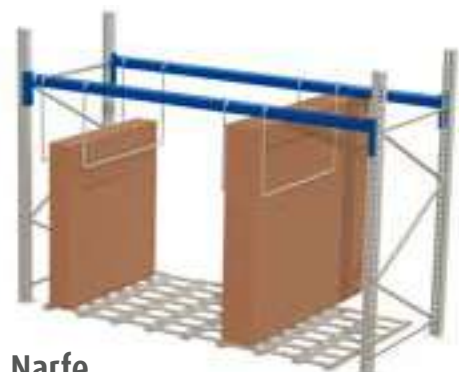

### Narfe

Standard rack with top-mounted perforated beams and dividers that provides access from both sides of the rack. Complete solution with a floor-mounted roller bed that makes handling effortless. Section width 2700 mm. Dividers are 800 mm high and 1100 mm deep.

ART. NO.	SPECIFICATION
61 25112709	Start section with 8 dividers
61 25112710	Add-on section with 8 dividers
AVD-8-1100A	Extra divider







# Accessories

Smart accessories help establish order and tidiness, making it easy to find products and increasing production efficiency. Organize your storage by dividing pallets into smaller components, and stack them on top of each other to save valuable space. Our pallet collar dividers vary in flexibility, strength, and the number of compartments, yet all are cost-effective and crafted from recyclable materials.

Are you operating in the food industry or another sector where the use of wooden materials is not feasible? We also offer pallet collar frames in plastic or galvanized steel sheet. Feel free to contact us!

More models and sizes  
available at  
[WWW.SMARTSTORING.EU](http://WWW.SMARTSTORING.EU)

*Neat as a pin!*



# Pallet accessories

A large quantity of goods is handled on pallets equipped with pallet collars. With Smart Storing's accessories, the process becomes significantly more practical for picking and storing components.

Difficult to choose?  
Contact us, and we'll help you!

Create smaller compartments using our pallet collar dividers, available in wood or plastic. Keep collars securely in place during transport with our collar grips. Facilitate stacking by using stacking corners or pallet separators



## Heavy duty pallet box dividers

To make a really sturdy unit for storing heavy items, we recommend using wooden dividers of the same 22 mm thickness as the pallet collar itself. Dividers come with metal brackets to hold them in place. Just snap these into place on the collars wherever you want to make a division and secure the bracket with one screw. Very useful if you have long heavy items to store, or a combination of different sized items to store together.

ART. NO.	SPECIFICATION
5903079	Length 554 mm, divider with 2 mounting brackets
5903080	Length 743 mm, divider with 2 mounting brackets
5903081	Length 1154 mm, divider with 2 mounting brackets

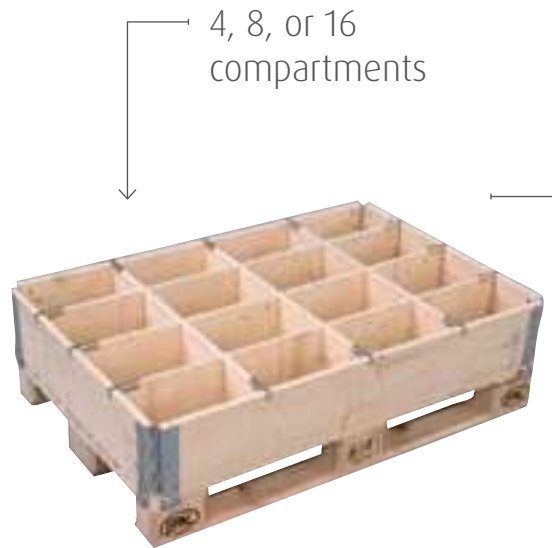

## Slotted plywood pallet collar dividers

Our standard dividers for Euro pallets are hung from the pallet collar sides using the integral metal fitting and are slotted to intersect with each other, thus dividing the box both lengthwise and crosswise to make your compartments. Complete sets for 4, 8 or 16 compartments. Also available for other pallet sizes.

ART. NO.	NO OF COMPARTMENTS	COMPARTMENT SIZE	PALLET TYPE
5903004	4	570 x 372 mm	Euro
5903008	8	372 x 280 mm	Euro
5903016	16	280 x 180 mm	Euro



## PALLET COLLAR DIVIDERS IN PLASTIC – FLEXIBLE, QUICK & EASY!

For smaller sized compartments and more flexibility, we suggest plastic box dividers. These come in two different sizes – Standard and Jumbo, depending on how heavy your items are and how many compartments you want. Made of recycled polypropylene/polyethylene mix, they're easy to cut to different lengths if required, but are normally supplied in 750mm and 1150mm lengths to fit the short and long sides of the pallet box.

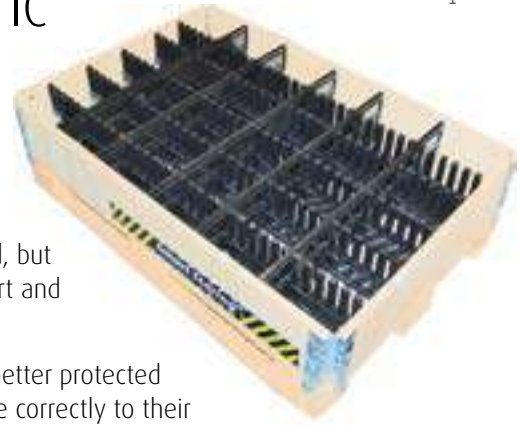

Smaller compartments and greater flexibility!

Plastic dividers are ideal for delicate or expensive tools, which are better protected by fitting the compartment size correctly to their dimensions. They are also used in food industry applications where wood is not permitted.



### Plastic dividers Jumbo

Made from recycled PP/PE. Very robust, thickness = 15 mm. Cut to length as needed.

ART. NO.	DIVISION	LENGTH	HEIGHT	THICKNESS
25 AVD301	37 mm	1150 mm	180 mm	15 mm
25 AVD302	37 mm	950 mm	180 mm	15 mm
25 AVD303	37 mm	750 mm	180 mm	15 mm



### Plastic dividers Standard

Made from recycled PP/PE. Thickness = 10 mm. Cut to length as needed.

ART. NO.	DIVISION	LENGTH	HEIGHT	THICKNESS
25 AVD201	28 mm	1150	120 mm	10 mm
25 AVD202	28 mm	950	120 mm	10 mm
25 AVD203	28 mm	750	120 mm	10 mm



### Slotted plywood pallet collar dividers

As a complement to our complete kits listed on the previous page, individual dividers are also available.

ART. NO.	SPECIFICATION	LENGTH	HEIGHT	FITS
5903010	3 slots	1154 mm	190 mm	FIN and EUR-pallet: lengthwise
5903020	3 slots	756 mm	190 mm	EUR-pallet crosswise or 1/2 EUR-pallet lengthwise
5903021	1 slot	756 mm	190 mm	EUR-pallet crosswise or 1/2 EUR-pallet lengthwise
5903030	3 slots	554 mm	190 mm	1/2 EUR-pallet: crosswise
5903040	4 slots	956 mm	190 mm	FIN-pallet: crosswise

Create your own compartment system or complement existing ones!



### Goods supports

Keep axis, tubes and other long items in place when stored on a pallet. These smart supports fit on EUR, FIN and 1/2 EUR-pallets and are available in three heights.

ART. NO.	HEIGHT	SPECIFICATION
5903600	200 mm	Set of 4
5903601	400 mm	Set of 4
5903602	600 mm	Set of 4



### Steel stacking corners

These durable galvanized steel corners facilitate pallet stacking by securing an additional pallet on top of a pallet collar, preventing slippage. A set of 4 corners supports loads of up to 2000 kg. Please be aware that the maximum weight capacity may vary based on the type and condition of pallets and pallet collars in use.

ART. NO.	SPECIFICATION
5903503	Galvanized steel, 100 pcs per package



### Pallet collar grip

If you're losing small items between the pallet collar and the pallet, you need a way to hold the collar down on to the pallet. Smart Storing's pallet collar grips do just that, with a simple piece of sprung wire, ridged on the underside so it stays where it's put. Simply snap into place - no need to tie or lash the collar down any more - and the grips can be used over and over. Available for one to four pallet collars, in sets of 4.

ART. NO.	SPECIFICATION
5903520	For 1 pallet collar in height, set of 4
5903521	For 2 pallet collars in height, set of 4
5903522	For 3 pallet collars in height, set of 4
5903523	For 4 pallet collars in height, set of 4



### Plastic stacking corners

These durable plastic corners facilitate pallet stacking by securing an additional pallet on top of a pallet collar, preventing slippage. Crafted from high-density polyethylene, our Stacking Corners boast longevity, washability, chemical resistance, and resilience to both heat and frost without cracking. A set of 4 corners supports loads of up to 2000 kg. Please be aware that the maximum weight capacity may vary based on the type and condition of pallets and pallet collars in use.

ART. NO.	SPECIFICATION
5903500-144	Black, package of 144 pcs
5903501-144	Yellow, package of 144 pcs
5903502-144	Blue, package of 144 pcs



## PALLET SEPARATORS

For temporary storage at an assembly station, whether you're using pallets with or without pallet collars, our pallet separators provide a solution for convenient component picking. Crafted from galvanized steel, these brackets secure over each corner of the pallet or pallet collar, supporting the next pallet with a gap in between.

**SMART CHOICE!**

Effectively creating an economical temporary pallet rack, this system optimizes floor space, improves ergonomics during component picking, and can be easily assembled and disassembled as needed.

We help you find the right solutions!

**INFO@SMARTSTORING.SE**  
**+46 304 80 90 80**



### Pallet separator – Collar to pallet

Sturdy galvanized steel brackets designed to fit securely over each corner of a pallet collar, offering robust support for the pallet stored above. Available with a convenient 250, 400 or 700 mm gap between pallets, our set of 4 pallet spacers can handle a load of up to 1000 kg, allowing you to efficiently stack pallets in height. Please be aware that the maximum weight capacity may vary based on the type and condition of pallets and pallet collars in use.

ART. NO.	SPECIFICATION
5903550	Free space between collar and pallet: 250 mm. Set of 4 pcs
5903552	Free space between collar and pallet: 400 mm. Set of 4 pcs
5903553	Free space between collar and pallet: 700 mm. Set of 4 pcs



### Pallet separator – Pallet to pallet

Sturdy galvanized steel brackets designed to fit securely over each corner of a pallet, offering robust support for the pallet stored above. Available with a convenient 250, 400 or 700 mm gap between pallets, our set of 4 pallet spacers can handle a load of up to 1000 kg, allowing you to efficiently stack pallets in height. Please be aware that the maximum weight capacity may vary based on the type and condition of pallets in use.

ART. NO.	SPECIFICATION
5903551	Free space between pallets: 250 mm. Set of 4 pcs
5903554	Free space between pallets: 400 mm. Set of 4 pcs
5903555	Free space between pallets: 700 mm. Set of 4 pcs



*Organize even more!*

# Picking and storage bins

Plastic bins offer an effective storage solution in warehouses or production, making it easy to find and pick components. They are ideal for use in many of our other products, including pull-out units and Compact Storage Units.

We help you find the right solutions!

**INFO@SMARTSTORING.SE**  
**+46 304 80 90 80**



## SELECT HEIGHT

Flexibox is available in four heights: 50 mm, 100 mm, 150 mm, and 200 mm.



### Flexibox

There were no storage organizers for small items on the market that fully met our customers' needs, so we introduced our own. Smart Storing Flexiboxes have a distinctive feature: the compartments are customizable, and the contents are easily visible at a glance, thanks to the removable clear plastic dividers. Comes complete with 12 dividers that gives 48 compartments.

ART. NO.	LENGTH x WIDTH x HEIGHT	SPECIFICATION
7864050	800 x 600 x 50 mm	48 compartments
7864100	800 x 600 x 100 mm	48 compartments
7864150	800 x 600 x 150 mm	48 compartments
7864200	800 x 600 x 200 mm	48 compartments



More models and sizes available at [WWW.SMARTSTORING.EU](http://WWW.SMARTSTORING.EU)

Grey crates are made from recycled plastic!



### Stackable Euro-crates

Euro-crates offer an efficient storage solution in warehouses or production, making the picking of components easy. They are well-suited for use in many of our other products, including pull-out units and Compact Storage Units. The crate size of 400 x 300 mm is suitable and popular for 100% pull-out units, accommodating 8 crates per shelf. The crate size of 600 x 400 mm is suitable for 70% pull-out units, accommodating 4 crates per shelf.



ART. NO.	ART. NO.	ART. NO.	OUTER DIMENSIONS	INNER DIMENSIONS	VOLUME	LOAD CAPACITY	PER PALLET
BLUE	RED	GREY	LENGTH x WIDTH x HEIGHT	LENGTH x WIDTH x HEIGHT			
XL43171B	XL43171R	22 E4317C	400 x 300 x 170 mm	368 x 268 x 167 mm	16 L	30 kg	96 pcs
XL64171B	XL64171R	22 E6417C	600 x 400 x 170 mm	568 x 368 x 166 mm	34 L	15 kg	48 pcs



Quality  
Swedish-made

### Component bins

If you need to organize, store, and locate your small components, our series of component bins is an excellent choice. They fit perfectly into our new Compact Storage Unit "CSU Light" and, with an adapter bar, also into our standard Compact Storage Units. Accessories such as labels and label holders help you maintain order and tidiness. These are high-quality, Swedish-made products crafted from high-impact polypropylene, featuring a cost-effective and compact ergonomic design.

COMPONENT BIN			DIVIDER		LABEL HOLDER, WITH 1 LABEL		
ART. NO.	SPECIFICATION		ART. NO.	SPECIFICATION	ART. NO.	WIDTH	SPECIFICATION
75 4009	Component bin D400 x W90 x H95 mm	→	75 0401	Divider P09, fits bin 75 4009	75 0500	135 mm	Holder incl label H35 mm
75 4012	Component bin D400 x W120 x H95 mm	→	75 0402	Divider P12, fits bin 75 4012	75 0501	60 mm	Holder incl label H35 mm
75 4018	Component bin D400 x W180 x H95 mm	→	75 0405	Divider P18, fits bin 75 4018	75 0502	75 mm	Holder incl label H35 mm
75 4024	Component bin D400 x W240 x H95 mm	→	75 0403	Divider P24, fits bin 75 4024			
75 4024-15	Component bin D400 x W240 x H150 mm	→	75 0404	Divider P24-15, fits bin 75 4024-15			



# Faster order picking!

## Marking and labelling

Efficiently labeling components, tools, and goods is pivotal for success in any business. Organizing items aids in quick retrieval, saving time, and averting costly errors.

Feel free to ask us for advice or samples, and we'll find the best solution for your needs!

At Smart Storing, prompt service is our commitment! Many of our products have a delivery time of fewer than 3 working days.

We firmly stand by both quality and environmental standards at Smart Storing. Our durable plastic pockets are designed to last, manufactured in Sweden using EU-approved plasticizers.

Our wide array of plastic pockets is tailored for various storage solutions, including pallets, pallet collars, containers, mesh containers, cardboard boxes, bins, Euro crates, and pallet box dividers. Need advice on self-adhesive, magnetic, or stapled pockets? Feel free to ask. Additionally, our clear PVC document holder with an integrated wire hanger is a versatile option available in six sizes, perfect for securely displaying labels in various settings.

### CUSTOM SIZES

We can manufacture all our plastic pockets and labels in custom sizes. Contact us for more information!

## Ortho-Phthalate free



### SWEDISH-MADE QUALITY

Our Swedish-made plastic pockets are crafted using long-lasting materials, guaranteeing durability and value for a modest investment. Request samples to explore and find the perfect fit for your needs.

### EU-APPROVED PLASTICIZERS

We use EU-approved plasticizers (free from harmful phthalates). Our products stand as the optimal choice, not just for their quality and functionality, but also due to their recyclability and production using the most environmentally friendly methods possible.





### Universal dokument holder with Wire Hanger

Our document holders are made from transparent plastic and feature an integrated flexible spring steel wire hanger. This unique hanger design enables versatile attachment to multiple locations, including pallet collars, pallet containers, wire containers, and various shelf edges. The attachment is securely welded into the holder, eliminating the need for additional tools during installation. Available in two variations, these holders can come with an open top or with a 90 mm high lid, ensuring added protection against moisture and dust. Additionally, models with fold-over flaps offer rain protection, making them suitable for outdoor use.

ART. NO.	FORMAT	WIDTH x HEIGHT	PACKAGING	SPECIFICATION
5901005	A5	275 x 160 mm	100 pcs	Landscape
5901006	A5	275 x 160 + 90 mm	100 pcs	Landscape, with fold-over flap
5901007	A4	245 x 320 mm	100 pcs	Portrait
59010071	A4	270 x 340 + 85 mm	100 pcs	Portrait, with fold-over flap
5901008	A4	325 x 235 mm	100 pcs	Landscape
5901009	A4	325 x 235 + 85 mm	100 pcs	Landscape, with fold-over flap

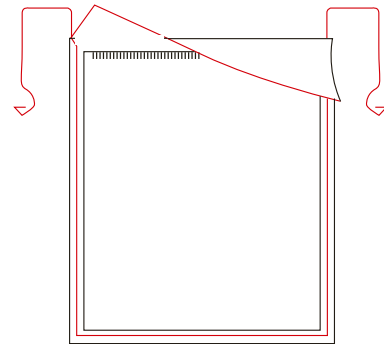

Don't forget the labels!

### Document Holder for thick documents

The document holder is pleated, allowing it to expand and store documents up to 20 mm thick. Perfect for reports, assembly and installation manuals, and much more. The back of the pocket has an adhesive surface covered with protective paper. Once you remove the protective paper, you have a self-adhesive surface for immediate attachment. The pocket has a lid for the opening to protect against dust and dirt. Available in sizes tailored for A4 and A5. Upon request, we can provide individual custom solutions.

ART. NO.	FORMAT	WIDTH x HEIGHT	PACKAGING
5901040	A5	255 x 210 x 12 mm	100 pcs
5901041	A4	330 x 250 x 40 mm	100 pcs

### Stock labels

Pre-printed yellow label, 180g paper. A simple tool for manually keeping track of inventory.

ART. NO.	FORMAT	WIDTH x HEIGHT	PACKAGING
5902011	A6	148,5 x 105 mm	100 pcs
5902000	A5	210 x 148,5 mm	100 pcs
5902010	A4	297 x 210 mm	100 pcs
5902012	Fits 5901028 for dividers	148,5 x 55 mm	100 pcs
5904000	Fits 5903000 for pallet block	135 x 95 mm	100 pcs

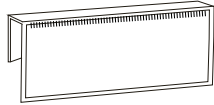

### Document holder for dividers

A document holder with a molded crease for hanging on the top edge of pallet collar dividers or other edges that are approximately 12 mm thick. The front page is made of transparent plastic, which protects the label from dirt and wear, and barcode labels can be scanned directly in place.

ART. NO.	WIDTH x HEIGHT	PACKAGING
5901028	165 x 60 + 12 mm	100 pcs



### Document holder for pallet block

Are available in two versions:

1. Perfectly designed for the middle block on a EUR pallet. Easily attachable using a staple gun or double-sided tape for versatility across various materials.
2. Specifically crafted for the outer block pocket on a pallet, effortlessly secured with Velcro straps. Ideal for RFID transponders or labels, allowing adaptable usage for EAN code scanning. Includes four insert pockets for labels, one on each side, offering flexible applications.

ART. NO.	WIDTH x HEIGHT	PACKAGING
5903000	145 x 100 mm	100 pcs. Document holder for center block
5901030	100 / 145 x 75 mm	100 pcs. Document holder for outer block

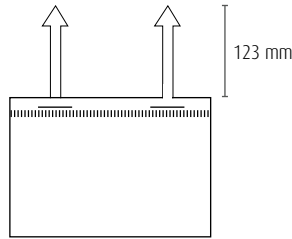

### Document holder with tabs

This document holder is secured with the integrated plastic tabs that are pulled through the pocket slots and locks in there. Easy to hang up and take down again. Ideal for mesh containers (Gitterbox) and similar. Especially useful for internal material handling where the holder can stay in place and the documents can be changed as necessary.

ART. NO.	FORMAT	WIDTH X HEIGHT	PACKAGING
5901015	A5	235 x 185 mm	100 pcs
5901016	A4	310 x 250 mm	100 pcs

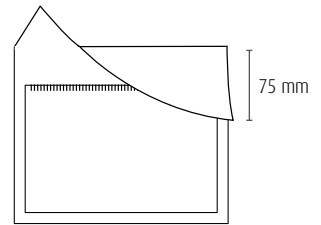

### Document holder with hole punched & flap

A flat plastic document holder with a hole punched for ease of hanging on different surfaces. Use either metal eyelets or tape to secure to mesh containers (Gitterbox) or plastic rivets for speedily fixing to cardboard boxes (can easily be removed afterwards).

ART. NO.	FORMAT	WIDTH x HEIGHT	PACKAGING
5901027	A5	235 x 200 + 15 mm	100 pcs
5901050	Plastic rivets, for document holder	diameter 10 mm	100 pcs
5901051	Metal eyelets	1,8 x 56 mm	100 pcs

The standard colour for our plastic pockets is blue or transparent. Upon request, we can offer red, green, and yellow pockets.

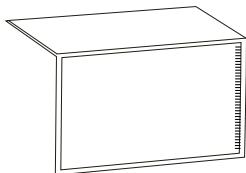

### Document holder for stacked boxes

The top edge is bent at a 90-degree angle and is easily inserted between two boxes to be held in place by the weight of the upper box. Labeling of boxes can then be done without the need to glue anything, leaving no residue on the surface upon removal. A high-quality pocket that can be used repeatedly.

ART. NO.	FORMAT	WIDTH X HEIGHT	PACKAGING
5901020	A5	235 x 170 x 53 mm	100 pcs
5901019	A4	310 x 230 x 68 mm	100 pcs

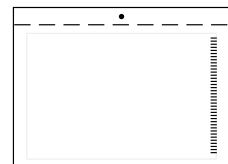

### Document holder with hole punched

A flat plastic document holder with a hole for easy hanging on various surfaces. Attach with either metal eyelets or tape for securing to a grid box or use plastic rivets for quick attachment to cardboard (easily removable afterwards).

ART. NO.	FORMAT / DESCRIPTION	WIDTH x HEIGHT	PACKAGING
5901021	Document holder A5	235 x 170 + 15 mm	100 pcs
5901050	Plastic rivet for document holder	diam. 10 mm	100 pcs
5901051	Metal eyelet	1,8 x 56 mm	100 pcs



**BESTSELLERS!**  
Simple and stable fastening on pallet collar

### Document holder for marking pallet collars

This document holder has a sturdy backpiece with a formed crease, providing easy and stable attachment to pallet collars or other edges that are approximately 22 mm thick. The front page is made of transparent plastic, protecting the label from dirt and wear. If you use barcode labels, you can easily scan the label without needing to remove it from the plastic pocket. Our standard colour is blue, but upon request, we also offer other colours like red, green, and yellow. The folded back edge ensures a secure fit and provides protection against dust and moisture during outdoor storage.

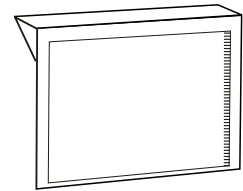

ART. NO.	FORMAT	WIDTH x HEIGHT	PACKAGING	SPECIFICATION
5901024	A6	165 x 188 mm	100 pcs	The crease on the top edge is 26 mm, and the folded back edge is 32 mm
5901000	A5	235 x 165 mm	100 pcs	The crease on the top edge is 28 mm, and the folded back edge is 35 mm
5901010	A4	310 x 234 mm	100 pcs	The crease on the top edge is 28 mm, and the folded back edge is 40 mm

Plastic pockets with magnets!  
Label steel shelf fronts, bundles of steel pipes, or sheets.



Neodymium magnets - Super strong adhesive force. Stays in place even under high loads.

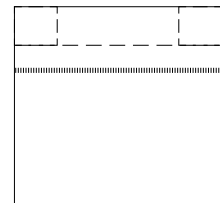
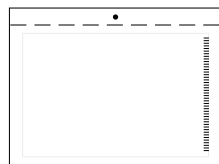

### Plastic wallet with double-sided tape or magnet

A plastic wallet designed for attachment with double-sided tape or a magnetic strip, which is mounted on the back panel. Our magnetic pockets are perfect for labeling materials that are magnetic, such as steel shelf fronts on Compact Storage Units. Another common use is for labeling bundles of steel pipes or sheets. The pocket with double-sided tape is intended for a more permanent attachment to a suitable surface where tape adheres. Hole diameter: 3.8 mm.

ART. NO.	FORMAT	WIDTH x HEIGHT	PACKAGING
5901022	A5 with tape	235 x 170 + 15 mm	50 pcs
5901023	A5 with magnet	235 x 170 + 15 mm	50 pcs

### Plastic wallet with neodymium magnets - extra strong adhesion

To achieve even higher adhesion strength, we offer plastic pockets with integrated neodymium magnets. Each of these magnets has an adhesion force of 3 kg. The highly self-adhesive power of neodymium magnets ensures that the pocket stays in place even during high loads, such as during transportation. The plastic wallet adheres immediately to metal surfaces, beams, storage and transport containers, or directly to the goods.

ART. NO.	FORMAT	WIDTH x HEIGHT	PACKAGING
5901034	A5	235 x 185 + 40 mm	50 pcs

# From order to delivery – How it works



## PURCHASE

Place your order by calling **+46 304-80 90 80** or send an email to **order@smartstoring.se**.

Some products can also be ordered through our online store at **www.smartstoring.eu**.



## PRICES

Prices for our products are provided in a separate price list. All prices are in Euro (EUR) and exclude VAT. Shipping, packaging, and packing materials are not included.



## DELIVERY TIME

The delivery time will be specified in your order confirmation.

Delivery time is calculated from the receipt of a correct order until the goods are dispatched from our factory.

The delivery date signifies when the goods depart from our factory. Kindly allow about 1 week for transportation to your location.



## ORDER CONFIRMATION

You will always receive an order confirmation via email.

Please verify that the information is correct.



## PAYMENT

We typically offer a 20-day credit term. We conduct a credit assessment for all new customers.



## SHIPPING

Delivery is charged at cost on all orders. We use different shipping agents depending on the destination country.



## WARRANTY

All products are fully guaranteed for 6 months from delivery. Thereafter the terms and conditions which apply are according to NL01.



## TRANSPORT DAMAGE

Visible transport damage must be noted IMMEDIATELY on the carrier's transport documents. Both visible and hidden transport damage must be reported to Smart Storing within 7 days.



## RETURNS & COMPLAINTS

No returns are accepted without a return number issued by us, including complaints. Always contact us in advance if you wish to return anything!



## GENERAL TERMS AND CONDITIONS

We follow delivery terms according to NL 01 (available upon request).

# Social media and videos

Follow us and stay updated with the latest news. Find us on Facebook, LinkedIn, Instagram, and YouTube.

On YouTube, you can find videos demonstrating how our products are used. Scan the QR code and watch the videos directly on your phone.

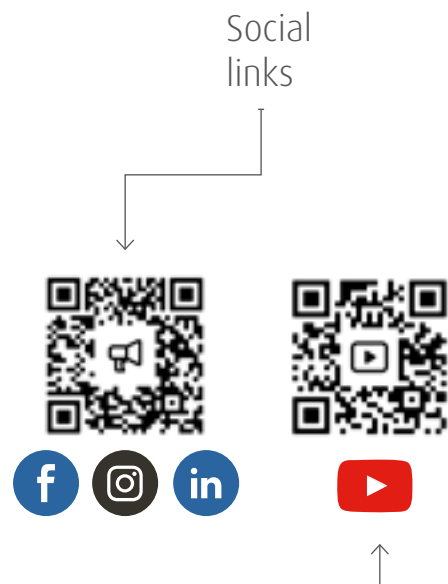

## NEWSLETTER

Register by emailing [news@smartstoring.se](mailto:news@smartstoring.se). Stay updated with the most important and latest news.

Subscribe to Smart Storing NEWSLETTER!

We send newsletters approximately 10 times a year.

## HEAD OFFICE CONTACT

TSM Smart Storing AB  
Töllås PI 433  
SE-473 91 Henån, Sweden

Phone: +46 304 80 90 80  
Email: [info@smartstoring.se](mailto:info@smartstoring.se)  
[www.smartstoring.eu](http://www.smartstoring.eu)



CO<sub>2</sub>-SMART™ printed material – [co2smart.se](http://co2smart.se)

Smart Storing Magazine, edition 4, 2023, is published by TSM Smart Storing AB. Editor-in-Chief: Kjell Johansson Layout: RavenGraphics.se  
Website: [www.smartstoring.eu](http://www.smartstoring.eu) Email: [info@smartstoring.se](mailto:info@smartstoring.se) Facebook.com/smartstoring LinkedIn.com/company/3149061

Sales are conducted both through retailers and directly to customers in Sweden, and exclusively through retailers in the rest of Europe. We reserve the right for any printing errors.

PERSONAL NOTES

Lined writing area consisting of 22 horizontal lines.







Some of our customers

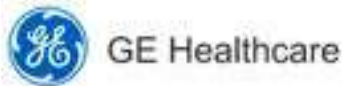

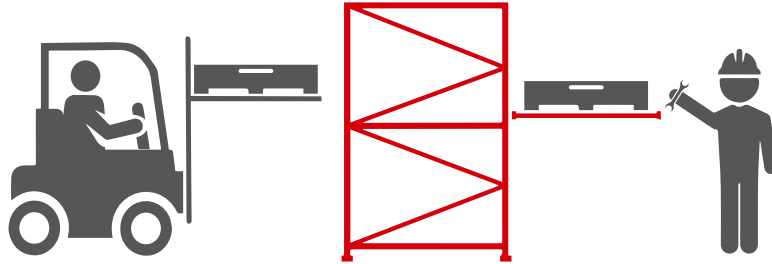

→ Kjell Johansson, MD Smart Storing

**”What drives me is the feeling of solving a problem.**

**We love to collaborate to find a tailored solution for the end customer.**

**Often, this solution becomes an innovation that becomes a product in the standard range.”**

A handwritten signature in purple ink, located at the bottom right of the page. The signature is stylized and appears to be the name of the person quoted in the text above.

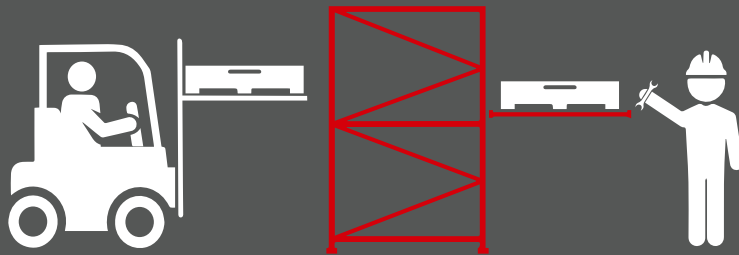

## Easy filtering for all products to help you quickly find what you need

In addition to our own  
products that you can find  
in this catalogue, we have  
a vast complementary  
range on our website that can make your warehouse

Much more on the website  
[WWW.SMARTSTORING.EU](http://WWW.SMARTSTORING.EU)



and storage even more efficient.

Moreover, there is easy filtering for all  
products to help you quickly find what  
you need.

*it's all about space!*



LOGITEC

DISTRIBUIDOR AUTORIZADO  
Idorsolo, 13 - P.E. San Isidro I  
48160 - Derio (Vizcaya)  
Tel. +34 944544580  
Web: [www.logitecsl.net](http://www.logitecsl.net)

DESIGN &  
MANUFACTURING  
IN SWEDEN  
**Smart Storing**

